

WWW.TRADING-SOFTWARE-COLLECTION.COM

MARKET SCIENCE

VOLUME II

Market Dynamics

BRADLEY F. COWAN

WWW.FOREX-WAREZ.COM
ANDREYBBRY@GMAIL.COM SKYPE: ANDREYBBRY

NOTE: Mr. Cowan is a collector of material relating to W.D. Gann and George Marechal. He would appreciate knowing of any such material or receiving (exchanging) copies. Of particular interest are clear original copies distributed years ago. Privacy and confidentiality can be expected if requested.

WWW.TRADING-SOFTWARE-COLLECTION.COM

BOOKS BY THIS AUTHOR

Please visit our web page to view details on any of these books or to print the confidential disclosure agreement that is required for either *Market Science* book.

<http://www.inetworld.net/cycles>

Four-Dimensional Stock Market Structures And Cycles

The first ten lessons of this series are contained within these two books. Lessons one through five deal with the four-dimensional geometric structures in financial markets. Lessons five through ten identify the cycles recurring along the faces of these structures. These cycles are applicable to any market.

This book is available by contacting:

Stock Market Geometry; P.O. Box 9756; San Diego, CA 92169-0756 USA.
(619) 221-7067; FAX (619) 225-9309; e-mail cycles@inet1.inetworld.net

Market Science - Volume I - Square Of Twelve

This book contains lessons eleven and twelve and proves that the square of twelve is the elemental unit of measurement within the soybean market.

- XI - Square Of Twelve
- XII - Vectorial Partitioning

This book requires a signed confidential agreement and is only available by contacting:

Stock Market Geometry; P.O. Box 9756; San Diego, CA 92169-0756 USA.

(619) 221-7067; FAX (619) 225-9309; e-mail cycles@inet1.inetworld.net.

(A discount is available for those who have already purchased the first set of books.)

Market Science - Volume II - Market Dynamics

This book contains lessons thirteen through sixteen and an update on stock market cycles and the growth spiral unfolding in that market, as of July, 1995.

- XIII - Non-Euclidean Price-Time Geometry
- XIV - Quantum Energy Levels Of Freely Traded Markets
- XV - Soybean Cycles
- XVI - Square Of Fifty-Two
- Also - Stock Market Cycle Update And Current Growth Spiral
- Also - Applications Of The Musical Fifth To Timing
- Also - Dimensions Of Ancient Monuments And Soybean Spirals

This book requires a signed confidential agreement and is only available by contacting:

Stock Market Geometry; P.O. Box 9756; San Diego, CA 92169-0756 USA.

(619) 221-7067; FAX (619) 225-9309; e-mail cycles@inet1.inetworld.net;

(A discount is available for those who have already purchased the first set of books.)

NOTICE OF TRADEMARKS

First time violations of trademark laws carry fines of up to \$250,000 and five years in jail.

"PTV" is a trademark of Bradley F. Cowan

"Price-Time Vector" is a trademark of Bradley F. Cowan

COPYRIGHT

Copyright © 1995 by Bradley Frank Cowan

All rights reserved. No part of this work covered by the copyright hereon may be reproduced or used in any form or by any means - graphic, or mechanical, including photocopying, taping, or information storage and retrieval systems - without permission of the author.

Any copy of this book issued by the author is sold subject to the condition that it **SHALL NOT BY WAY OF TRADE OR OTHERWISE, BE LENT, RE-SOLD, HIRED OUT, OR OTHERWISE CIRCULATED, WITHOUT THE AUTHOR'S PRIOR CONSENT**, in any form of binding or cover other than that in which it is published, and without a similar condition including this condition being imposed on a subsequent purchaser.

WWW.FOREX-WAREZ.COM
ANDREYBBRY@GMAIL.COM SKYPE: ANDREYBBRY

*There is no logical way to the discovery of these elemental laws.
There is only the way of intuition, which is helped by a feeling for
the order lying behind the appearance.*

... Albert Einstein

TABLE OF CONTENTS

LIST OF FIGURES	iii
LIST OF TABLES	iii
RECOMMENDED SUBJECTS TO STUDY BEFORE STARTING THIS COURSE	iv
PREFACE	v
INTRODUCTION	1
LESSON XIII - NON-EUCLIDEAN PRICE-TIME GEOMETRY	5
INTRODUCTION	5
LINEAR SUPPORT AND RESISTANCE	6
A ROTATED CIRCLE FORMS A SPHERE	9
NON-EUCLIDEAN GEOMETRY	13
CURVILINEAR PRICE-TIME MOTION IN THE SOYBEAN MARKET	18
A REVOLVED SPHERE CREATES A TORUS	21
THE TORUS IN THE DOW JONES INDUSTRIAL AVERAGE	22
THE TORUS IN THE SOYBEAN MARKET	25
THE TORUS IN THE LIVE CATTLE MARKET	25
CONCLUSION	27
LESSON XIV - QUANTUM ENERGY LEVELS OF FREELY TRADED MARKETS	31
INTRODUCTION	31
STRUCTURE OF THE ATOM	32
QUANTUM ENERGY LEVELS IN THE SOYBEAN MARKET	35
ENERGY LEVELS FROM THE 1948 TOP	39
GROWTH SPIRAL FROM 1977 TO THE PRESENT	39
DETERMINING ONE ELEMENT OF THE SUM GIVES BOTH ELEMENTS	45
FIBONACCI RATIOS IN CURRENT GROWTH SPIRAL	46
EXAMPLE OF PTV™ PROJECTION	50
CONCLUSION	53
LESSON XV - PLANETARY CYCLES IN SOYBEANS	57
INTRODUCTION	57
URANUS	58
URANUS TRINE AND MAJOR SOYBEAN TOPS	58
URANUS TRINE AND MAJOR SOYBEAN BOTTOMS	61
ALTERNATING POLARITY OF URANUS TRINES	65
ADVANCED TOPICS - URANUS AND THE "SQUARE OF NINE"	67
SATURN 29.5-YEAR SIDEREAL CYCLE AND SOYBEAN CORRELATION	70
SATURN-URANUS SYNODIC CYCLE AND SOYBEAN CORRELATION	73
JUPITER-URANUS SYNODIC CYCLE AND SOYBEAN CORRELATION	76
JUPITER-URANUS SYNODIC CYCLE AND SOYBEAN CORRELATION	80
45 AND 22.5 DEGREE HARMONICS OF THE JUPITER-URANUS CYCLE	80
30 AND 15 DEGREE HARMONICS OF THE JUPITER URANUS CYCLE	83
CONCLUSION	86
LESSON XVI - SQUARE OF FIFTY-TWO	89
INTRODUCTION	89
MESOAMERICAN CALENDARS	89
SQUARE OF FIFTY-TWO AND THE SOYBEAN MARKET	92
13-YEAR INTERVAL IN THE SOYBEAN MARKET	94
URANUS TRINE IS CORRELATED WITH THE 13-YEAR INTERVAL	98
APPENDIX A - DATA SET CHOSEN FOR THIS ANALYSIS	101
APPENDIX B - DEFINITION OF THE PRICE-TIME RADIUS VECTOR™	105
APPENDIX C - CURRENT STOCK MARKET GROWTH SPIRAL AND CYCLE UPDATE	107
STOCK MARKET CYCLES	107
CURRENT STOCK MARKET GROWTH SPIRAL	109
DOMINANT PTVS™ ARE RELATED TO A FUNDAMENTAL UNIT	113
DOMINANT PTVS™ ALSO SHOW UP IN PRICE AND TIME	114
THE PTV™ ESTABLISHES THE RATE OF VIBRATION	117

APPENDIX D - MUSICAL FIFTH IN PRICE-TIME	119
MUSICAL FIFTH IN THE DOW JONES INDUSTRIAL AVERAGE	125
APPENDIX E - CORRELATION BETWEEN THE DIMENSIONS OF ANCIENT TEMPLES AND THE VECTORIAL EXPANSION OF THE SOYBEAN MARKET	129
TOWER OF BABEL	130
ZIGGURAT OF UR	133
TIAHUANACO RUINS	134
APPENDIX F - SQUARES IN 1966 - 1982 STOCK MARKET	135
FUTURE AREAS OF STUDY	137

LIST OF FIGURES

13.1	Rotation Of A Vector, (a) Around A Single Axis; (b) Around Two Orthogonal Axes	11
13.2	A Plane Intersecting A Cylinder At A Right Angle Creates A Circle That Gives The Appearance Of An Ellipse When Viewed From The Side	12
13.3	A Curved Tunnel Forms A Nautilus Shell	13
13.4	Euclid's Fifth Axiom Concerning Parallel Lines	15
13.5	Sum Of The Three Inner Angles Of A Triangle On A Plane Is 180°	15
13.6	Meridian Circles Are Orthogonal To The Equatorial Circle, Even Though Meridian Circles Meet At Two Common Points	16
13.7	The Sum Of The Three Inner Angles Of A Triangle On The Surface Of A Sphere Is Greater Than 180°	17
13.8	A Sphere Revolved 360 Degrees Forms A Torus	21
13.9	Tori Increase In Size With Increasing Energy Levels	29
14.1	Vectorial Expansion In Price-Time From A Common Point Of Origin	35
15.1	Alternating Polarity Of Turning Points Associated With Uranus Trines	66
15.2	Uranus Is Nineteen Times Further From The Sun Than Is The Earth	68
15.3	Square Of Nine	69
B.1	Definition Of The Price-Time Radius Vector™	105
E.1	Dimensions Of The Tower Of Babel In Sumerian Feet And The Square Of Twelve	130
E.2	Dimensions Of Zigurat Of Ur In Sumerian Feet And The Square Of Twelve	133
E.3	Tiahuanaco Ruins In Bolivia And The Square Of Twelve	134
F.1	Squares From Figure 5.2 In <i>Four-Dimensional Stock Market Structures And Cycles</i>	135

LIST OF TABLES

14.1	Orbital Available To Electrons In Principal Quantum Levels	34
14.2	Vectorial Expansion Across The Growth Spiral From February, 1920 To October, 1969	36
14.3	Quantum Energy Levels In The Vectorial Expansion Measured From The Opening Of the Tunnel	38
14.4	PTV™ Calculations For Chart XIV.C Using Daily Data	42
14.5	Relation Of Paired PTVs™ To The Sequence Of Odd Integers	44
14.6	Fibonacci Relations Within The Current Growth Spiral (Declines)	48
14.7	Fibonacci Relations Within The Current Growth Spiral (Rallies)	50
15.1	Uranus Trines And Soybean Tops 1918 - 2001	61
15.2	Uranus Trines And Soybean Bottoms 1932 - 2016	63
15.3	Saturn Cycle And Soybean Tops 1925 - 2013	70
15.4	Saturn Cycle And Soybean Bottoms 1940 - 1999	73
15.5	Saturn-Uranus 15° Axes And Soybean Cycles 1969 - 1996	75
15.6	Jupiter-Uranus Harmonics And Soybean Cycles 1973 - 1994	79
15.7	Jupiter-Uranus 22.5° Axes And Soybean Cycles 1984 - 1996	82
15.8	Jupiter-Uranus 15° Axes And Soybean Cycles 1989 - 1994	85
16.1	Uranus Trine And The 13-Year Interval	98
C.1	PTV™ Calculations For Chart C.2 (DJIA)	111
D.1	PTV™ Calculations For Chart D.1 (1913 - 1969)	120
D.2	Ratio Of The Musical Fifth In 1913 - 1969 Spiral	122
D.3	PTV™ Calculations For Chart D.2	125
D.4	Musical Fifth In The Stock Market (1966 - 1982)	126
E.1	Vectorial Expansion In Soybeans 1978 - 1992 And The Tower Of Babel	131

RECOMMENDED SUBJECTS TO STUDY

The subjects listed below are related to the material presented in this work. These topics are listed for those who wish to develop a background of knowledge related to this subject material.

Measurements Of Ancient Monuments And Temples

The builders of the ancient monuments (whomever they were) used the same mathematical principles and ratios found in the price-time changes of present day financial markets. Among those structures to be carefully studied are: the Tower Of Babel, the Great Pyramid at Giza, the Tiahuanaco Ruins in Bolivia, and the Ziggurat of UR.

Mayan And Aztec Calendars

Atomic Structure And The Periodic Table Of The Elements

Study the change in atomic structure as the elements progress up the periodic table of the elements.

Non-Euclidean Geometry

Nothing moves in a perfectly straight line because one does not exist.

Analytic Geometry

Rotation of solids

Celestial Navigation

Triangulation

Natural Growth Spirals

Study the mathematical relationships within naturally occurring growth spirals such as the nautilus shell, the horns of bulls, and galactic spirals.

WWW.FOREX-WAREZ.COM
ANDREYBBRV@GMAIL.COM SKYPE: ANDREYBBRV

PREFACE

One frustration the author has experienced while reading books about financial market timing is that page after page of "filler" material must be waded through before the final point is reached. This is typically the case because authors only have one or two important points to make and find it necessary to present that knowledge in an entire book. As a result, most 200 page books can be effectively summarized in ten pages or less.

With this in mind, the material in *Market Science* has been presented in a very direct manner. The general style is to get right to the point then immediately move on to the next point without adding any "filler" material. Indeed, past readers have commented that entire books could be written on material presented in just a few pages of *Four-Dimensional Stock Market Structures And Cycles* and *Market Science*. The reader should remember this because if he tries to quickly read this material many highly relevant facts will be missed, as evidenced by the number of readers that have contacted the author with questions that were already addressed in previous books. These readers missed the concepts because they read the books too quickly, incorrectly expecting the concentration of relevant facts to be similar to other market timing books they have read.

When readers are introduced to this material by first reading *Four-Dimensional Stock Market Structures And Cycles* they often comment on its apparent complexity. This reaction is typical when new subjects are studied, especially something as original as this material. However, the author is confident that those who genuinely make the effort to study these topics in greater detail will find them much easier to understand. Those who initially find this material difficult can be reassured that others have had similar reactions but have ultimately learned how to apply these techniques to their specific markets.

It was written in *Four-Dimensional Stock Market Structures And Cycles* that Einstein's theory of relativity initially sounds complex to the novice but all that knowledge ultimately reduces to a simple equation, $E=MC^2$. In many ways, a mastery of vectorial market analysis progresses in a similar manner with what initially appears as a complex method of analysis becoming more and more simple as it is practiced with discipline.

Natural law is ultimately proven by its elegant simplicity.

INTRODUCTION

There is harmony and order in the universe that man can only dream of fully understanding. Our greatest achievements pale in comparison to the complexity of something as simple as a fruit fly. This simple creature has abilities to locate food, transport itself to that food, and to avoid potential predators with a proficiency that we only partly understand.

However, as an integral part of nature we can do our best to observe and model our environment within the limits of our abilities. The tools that we have developed to do this fall into the general category of "science", which Webster's dictionary defines as:

Science - 1. The study and theoretical explanation of natural phenomena. 2. A systematic activity requiring study and method. 3. Knowledge, especially that acquired through experience.

All three of these definitions apply to the material presented in *Market Science* because financial markets are certainly a natural phenomena requiring study, method, and experience to master. Unfortunately, those comfortable applying science to such things as chemistry and engineering do not realize that these same disciplined methods of measurement and analysis apply to determining the trend and cause of financial market movements. *Market Science* clarifies how some of the knowledge gained from the study of the sciences can be used in market timing. As stated many times in previous writings, market movements are contained within the limits of points of force that are predictably spaced in price-time. These points systematically attract and repel price movements as time unfolds. Therefore, all the natural laws that allow chemists, physicists, and engineers to determine the effects of force and stress can be applied to these points of force in price-time.

The material presented in this volume of *Market Science* is some of the most valuable ever written about financial market timing. This is because it is not only proven that the spacing between points of force in price-time occurs with consistency, but also that the magnitude of a PTV™ at any given position of the growth process is predictable decades in advance. To date, no methodology has been presented that is as accurate in identifying future points in price-time, provides such an understanding of the driving forces behind financial market movements, and supports the presented market analysis with scientific facts as does the material contained in *Market Science*.

Volume I of *Market Science, Square Of Twelve*, demonstrated the square of twelve relationships in price-time in the soybean market. Price levels, time cycles, and more importantly price-time spatial relationships are defined in this market by 144, which was considered by the ancient astronomers and geometers as a sacred number.

Archeologists have verified that ancient civilizations all over the world used this number in the layout of their sacred temples and monuments. These civilizations include the Inca, Maya, Aztecs, Sumarians, Celts, Greeks, Egyptians, and others whose identity remains a mystery. All these civilizations built monuments that incorporated the sacred number of 144 into their physical dimensions. This was the highest possible tribute to their gods.

Volume II of this series, *Market Dynamics*, expands on the material presented in Volume I by showing that the expansion or contraction of the growth spiral in soybeans is defined by a simple number series and multiples of the square of twelve. This number series will be shown to be the same progression found in the expansion of energy levels in the atom as the electrons move into different orbitals. The examples provided prove that the accuracy of this technique allow the analyst to define the magnitude of PTVs™ within two units of "cent-days" when projected into the future for a time frame exceeding a decade.

This work also shows the correlation between the long-term planetary cycles and the major tops and bottoms in soybeans, with cyclic projections made into the future for the next twenty years.

Because market advisory services are attempting to implement the author's cycle work into their commercially distributed publications, this analysis does not provide the exact phasing of the synodic cycles, nor does it show the locations of the shorter term cycles. Past experience has shown that when the author discloses the exact location of these cycles it is only a matter of weeks before this information is published by others.

Also included in this volume of *Market Science*, is an update of the stock market growth spiral that has been unfolding, since the crash of 1987. The vectorial relationships within this spiral have worked out exactly, using hourly time components. This information is included in Appendix C because it does not directly address the soybean market. However, the general concepts are applicable to all markets.

The planetary cycles presented in *Four-Dimensional Stock Market Structures And Cycles* are updated to July, 1995 showing that anyone who read those books and did their homework should have profited tremendously from the cycle bottoms and tops that they predicted.

Four-Dimensional Stock Market Structures And Cycles was released to the public in October, 1993 and many of the dominant cycles were only shown up to the June, 1992 top. However, every movement since that date has been closely correlated with the cycles outlined in that work.

Appendix F of this work looks at the similarities between the dimensions of ancient temples and the vectorial expansion of the growth spiral in the soybean market. This is only a brief introduction to the subject and is included here to pique the reader's curiosity about the possible extent of knowledge of our ancient ancestors.

LESSON XIII

NON-EUCLIDEAN PRICE-TIME GEOMETRY

The assumption that the sum of the three interior angles of a triangle is less than 180° leads to a curious geometry, quite different from Euclidean, but thoroughly consistent, which I have developed to my entire satisfaction. ... Carl Friedrich Gauss (1824)

The value of Euclid's work as a masterpiece of logic has been very grossly exaggerated. ... Bertrand Russell

INTRODUCTION

The type of geometry learned by most high school students is called "Euclidean". This geometry formally originated with the publication of *Elements* by Euclid around the year 300 B.C., and is most commonly recognized by its axioms and postulates concerning parallel lines, congruent angles, etc. This lesson shows that motion between points of force within price-time is rarely linear and hence, application of "non-Euclidean", or hyperbolic, geometry is needed to accurately model its behavior.

**THE HYPERBOLIC NATURE OF PRICE-TIME IS A
CONSEQUENCE OF INCLUDING THE ELEMENT OF TIME.
WHEN THIS IS DONE, ALL THE LAWS OF NATURE
GOVERNING TIME MUST BE APPLIED, INCLUDING ITS
CURVILINEAR RELATION TO SPATIAL ORIENTATION.¹**

Among the tools used by even the most experienced traders are well established support and resistance lines because they provide one of the easiest methods to use for projecting the future direction of price-time action. When price-time has unfolded enough on a two-dimensional chart to record two points that define major tops or bottoms the natural inclination of most traders is to connect them and extrapolate a trendline into the future.

A closer look at price-time reveals that trends are not always linear, but often times the action follows a curvilinear path. Which of these two forms the price-time action follows depends on the relative location within the unfolding growth process and the time frame being studied. For example, if only a small slice out of a gradually changing arc is looked at it gives the appearance of a straight line. It is not until the entire arc is seen that its true curvature is apparent. Sailors who use sextants are aware

¹ This is what Albert Einstein referred to as the curvilinear nature of "space-time".

of this fact when they try to locate their position at sea. Their techniques allow them to plot points along a "LOP" (line of position), which is in reality a small slice out of an arc along the surface of the Earth. To the sailor, this arc seems to be linear because it curves very little within the limits of measurement.

Once it is determined that a trend is contained by an arc, the analysis becomes mechanical because an arc can be defined by an equation. This provides the analyst with the ability to precisely calculate where the dominant support and resistance is at any given time.

This lesson begins by briefly studying traditional linear trend lines and showing the location of the most important of these in the cash soybean market. Then, non-Euclidean price-time motion will be studied with examples given in a variety of time frames and markets. Finally, the geometric forms that these curvilinear vectors define will be studied.

LINEAR SUPPORT AND RESISTANCE

Chart XIII.A, which is a complete record of the cash soybean market beginning when data was first recorded by the USDA in October, 1913 and continuing through December, 1994, shows examples of both linear and curvilinear support/resistance. This chart shows that the line that provided the resistance at the two major tops in 2/1920 and 1/1948 is also the support line that stopped the decline 57 years later in 12/1975.

WHEN A RESISTANCE LINE IS PENETRATED DURING A STRONG RALLY IT BECOMES A SUPPORT LINE FOR FUTURE DECLINES.

Similarly, when a support line is broken during a decline it provides levels of resistance for any future rallies. This fact must be remembered because any future support lines are secondary in importance to the long-term line that originated in 1920. Because this line has been in effect for the longest period of time it is stronger than all other support lines.

This resistance line changed to a support line when it was penetrated at a price level of 424 during the powerful advance in 2/1973. When this line was broken it confirmed completion of a growth process of nearly 60 years and the beginning of the long-term growth process that is currently unfolding.

Notice the narrowing distance between the line connecting the tops and the curve connecting the bottoms between

WWW.FOREX-WAREZ.COM
ANDREYBBRY@GMAIL.COM SKYPE: ANDREYBBRY

CHART XIII.A

LINEAR AND CURVILINEAR TRENDS

Prices shown on this graph are monthly averages received by farmers throughout the USA. These prices were recorded by the USDA at grain silos.

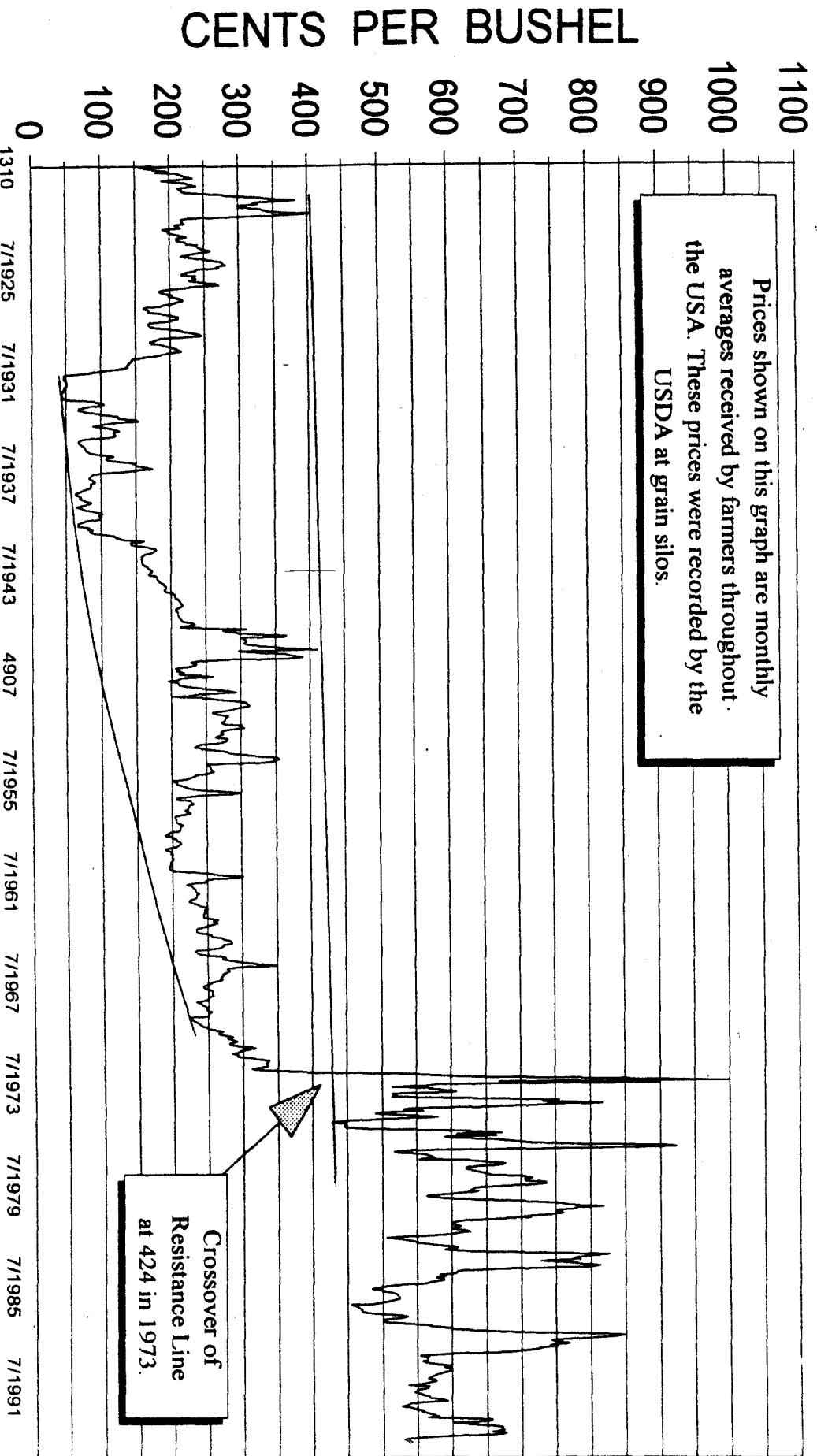

1932 and 1969. This is because the growth process during this time was contracting, resulting in progressively smaller price-time swings.²

Since breaking out above the 1920-1973 resistance line, the market has traded at much higher prices and the price swings have been much more dramatic within shorter time intervals. Chart XIII.A shows that the price-time action between 1969 and 1989 was typically vertical, moving straight up, then straight down, then straight up again. Compare this behavior with the 1913-1969 growth spiral where the price swings were smaller over a similar time interval, even when measured on a percentage basis. This behavior is typical in nature when energy is added to a stable system. For example, when energy is added to an atom in the form of radiation the electrons become excited and move away from the nucleus. They not only move further away from the nucleus, but their motion is also faster than at the lower energy level.

A quick review of Chart XIII.A shows that there has been relatively little price movement since the bottom of 10/1989, meaning that this market has been a very poor choice for traders interested in benefiting from high price volatility. The only exception to this dull activity was the rally into the 7/1993 top and the decline retracing that advance one year later. Traders buying futures or options in a slowly moving market such as this will lose money waiting for the prices to change because the time premium quickly runs out. This is a good example of how traders must be versatile in their trading techniques. When a market is dull the time premium on options is a nemesis for any "buy and hold" trader. However, bad news for one trader is usually good news for another and a dull market is no exception. A trendless market is ideal for selling options or credit spreads and waiting for the time premium to expire. This is especially true just after a large move because time premiums are usually at their peak at that point. In other words, there is a trading vehicle for every market condition, but the trader must be able to quickly adjust to the existing situation.

After the growth process completed in 1969, energy entered the system allowing the market for the first time to break through the long-term resistance line that had contained price increases since 1920. This resulted in the largest price movement in soybean history with prices quadrupling in less than four years from the low of \$2.23 in 10/1969 to the high of \$10.00 in 6/1973.

² Contraction of the growth process does not imply that the price trend is down. It simply means that the price-time swings are getting smaller, which can happen in an upwardly trending market. A common example of a contracting spiral that is trending upward is the "diagonal triangle" configuration found in Elliott Wave or the "pendant" in traditional technical analysis.

The Dow Jones Industrial Average has been contracting since the crash of 1987, even though prices have been increasing. This contraction is verified in Appendix C by noting that the successive declines since the crash have been getting smaller.

The price increase from the point of penetration of the resistance line in 2/1973 to the final spike top of 10.00 dollars/bushel in 6/1973 was the fourth square of twelve. That is, $1000 - 424 = 576$.

Another example of linear support occurred more recently. Chart XIII.B shows that the four bottoms in 10/1989, 7/1991, 10/1992, and 10/1994 are on a line. This support line was studied in Appendix D in *Square Of Twelve* where it was shown that lines drawn parallel to it create four equal divisions of support and resistance measured from the top in 1988.

This discussion of linear support was intentionally brief because the general subject is already well known. The main objective was to show the locations of these long-term lines in the cash soybean market because most analysts are not aware of their existence, especially the support/resistance line that has been in affect since 1920.

The following sections study the "non-linear", or curvilinear, nature of price-time. These curves will be shown to be at least as important as their linear counterparts in defining areas of support and resistance.

A ROTATED³ CIRCLE FORMS A SPHERE

Figure 13.1.a shows that if a vector of constant length is rotated 360 degrees around a single axis the tip of the vector defines a series of points on the circumference of a circle with the origin of the vector at the center of the circle.⁴ The rotational axis in this figure is perpendicular to the page of observation.

Figure 13.1.a is the same as Figure 7.3.a in *Four-Dimensional Stock Market Structures And Cycles* and Figure 11.2.a in *Square Of Twelve*. Obviously, it is very important.

If a second rotational axis is added to Figure 13.1.a that is parallel to the page it will be at a right angle to the rotational axis in Figure 13.1.a. Rotation of a circle around this second axis creates a series of circles, as shown in Figure 13.1.b. This is the process used to define meridian circles around the Earth. Meridian circles are spaced fifteen degrees apart around the globe and come together at two common points at the north and south poles.

Calculus proves that the process of rotation of a circle around an axis defines a perfect sphere.

³ A body is "rotated" when it is turned around an axis that is contained within the perimeter of the body, such as the Earth rotating around its axis in 24 hours. In contrast, a body is "revolved" when it is turned around an axis that is external to the perimeter of the body, such as the Earth revolving around the sun in 365 days.

⁴ This is Euclid's Postulate III.

CHART XIII.B

RECENT LINEAR SUPPORT AND RESISTANCE

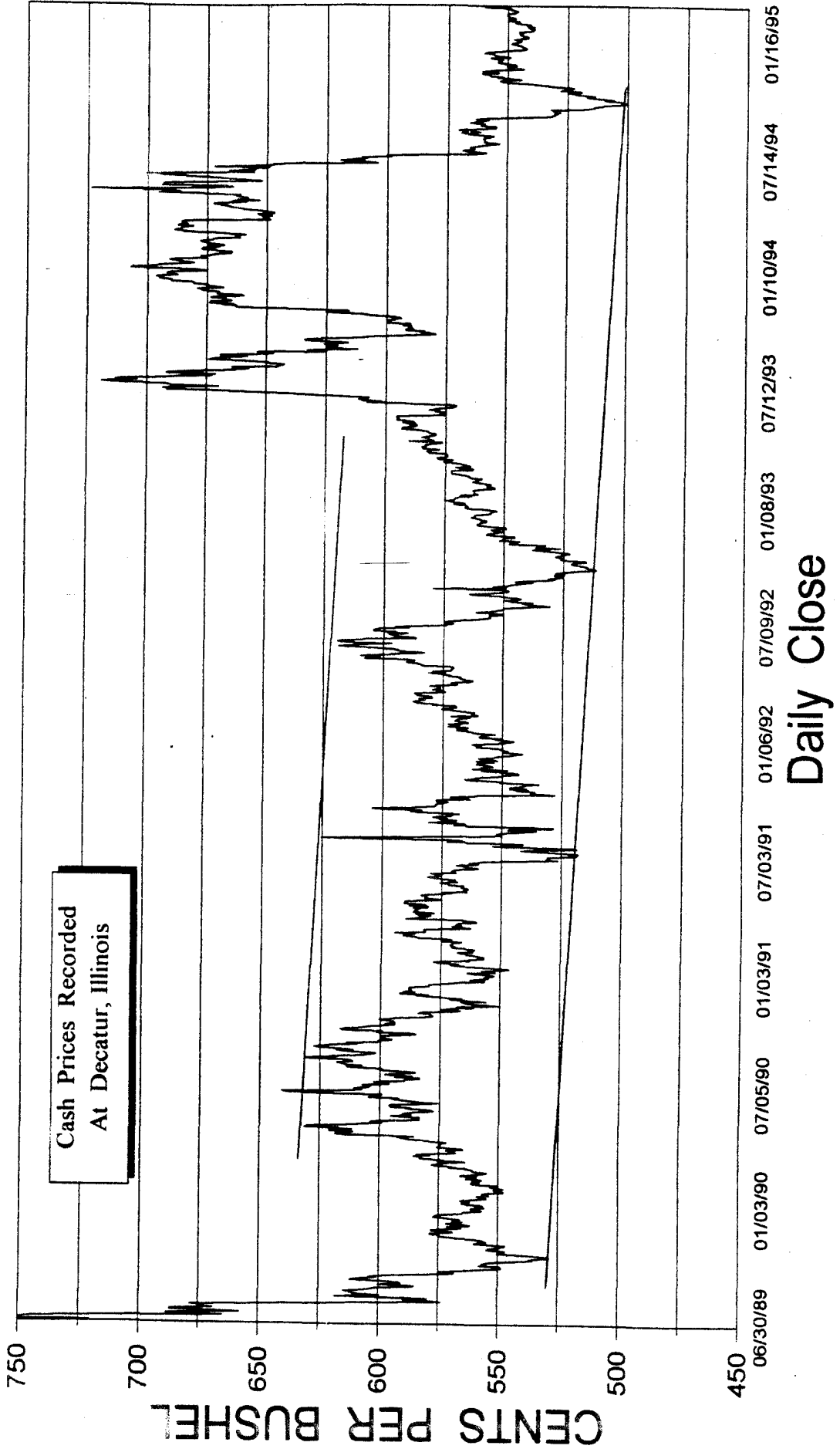

WWW.FOREX-WAREZ.COM
ANDREYBBRY@GMAIL.COM SKYPE: ANDREYBBRY

Meridian circles, which are often called "great circles", define the path taken to find the shortest distance between two points that have a north-south orientation. If someone wants to move from any point on the surface of a sphere to another point through the shortest possible distance they will follow an arc that is centered at the center of the sphere and whose radius is equal to the radius of the sphere. This understanding of arcs, circles and spheres is important to financial market analysis because,

AN ARC ON A PRICE-TIME CHART IS THE MOVEMENT OF A POINT OF FORCE ALONG A CURVED SURFACE, OUT OF WHICH ONLY A SMALL SLICE IS SEEN AT ANY ONE TIME.

Depending on the angle of the observer, this curvilinear movement may or may not appear as a perfect arc out of a circle. For example, there is only one circle in Figure 13.1.b that gives the appearance to the observer of perfect roundness because it is the only one perpendicular to the observer's line of vision. All other circles in this figure are at some angle relative to the observer's line of vision other than ninety degrees. Therefore, all but one of these circles appear as ellipses as they rotate around the axis of the sphere until the circle that is parallel to the observer's line of vision is reached, which in Figure 13.1 is shown as a vertical line.

Figure 13.2 shows the concept of circles appearing as ellipses where two parallel planes intersect a cylindrical tunnel at right angles to the central axis of the tunnel.

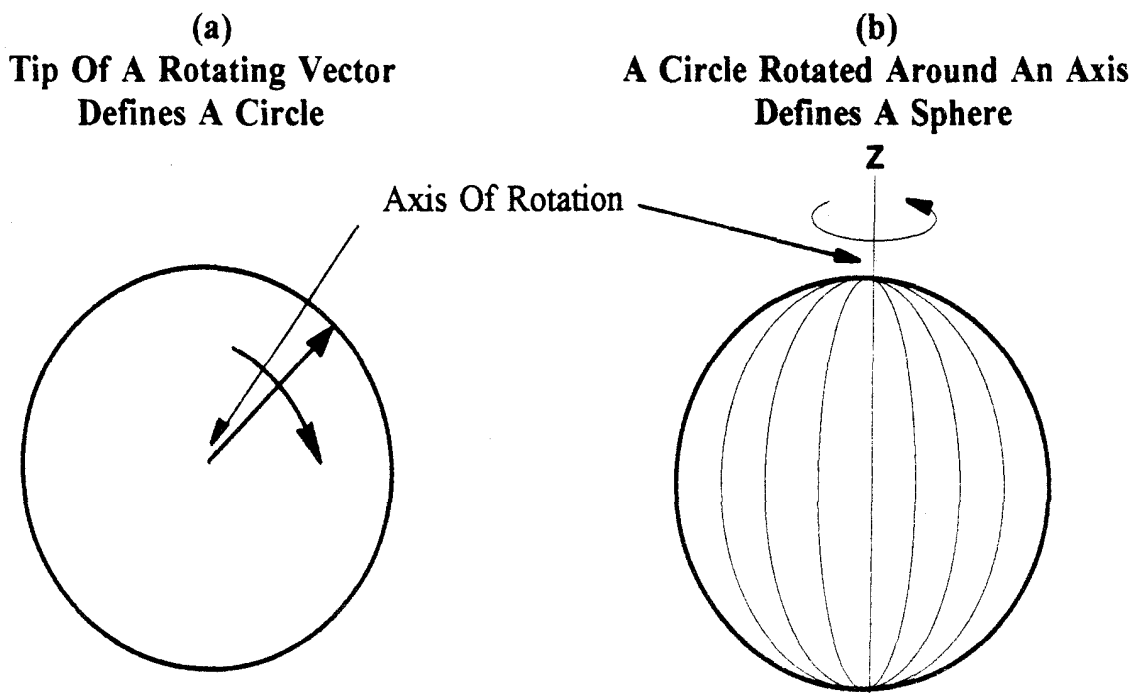

Figure 13.1
 Rotation Of A Vector;
 (a) Around A Single Axis; (b) Around Two Orthogonal Axes

If the central axis of the tunnel in Figure 13.2 is curved into a logarithmic spiral, rather than a straight line, a shape similar to a nautilus shell is formed. Figure 13.3 shows that when this nautilus shell is split down the middle the elliptical curves shown in Figure 13.2 are revealed.⁵

This is the identical configuration formed in financial markets where,

THE ELLIPTICAL APPEARANCE OF PRICE-TIME MOVEMENTS IS A CONSEQUENCE OF THE ANGLE OF THE OBSERVER'S LINE OF VISION. IN REALITY, THESE MOVEMENTS ARE SLICES OUT OF A SPIRAL THAT IS SIMILAR IN FORM TO THE NAUTILUS SHELL.

Perfect cylinder

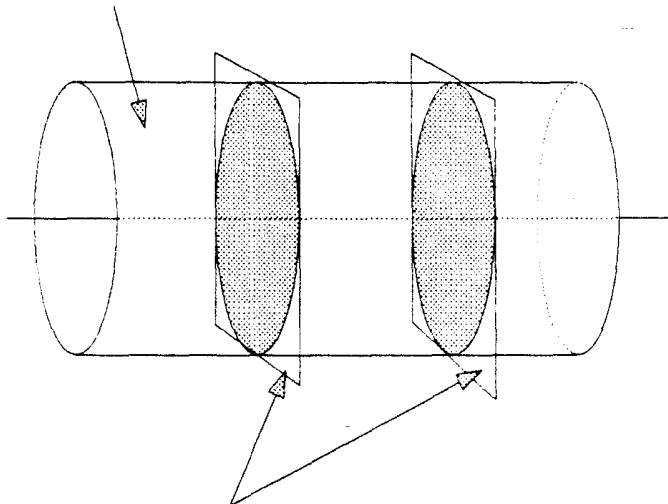

The points where the planes intersect the tunnel form circles that appear to be ellipses when viewed at an angle that is not perpendicular to their surfaces.

Figure 13.2

A Plane Intersecting A Cylinder At A Right Angle Creates A Circle That Gives The Appearance Of An Ellipse When Viewed From The Side

⁵ The cover of the book *Curves Of Life* by Theodore Cook, ISBN 0-486-23701-X, shows a good example of this. Notice when looking at the picture in that book that only half of the ellipse is seen. This is because the remainder of the ellipse is on the other side of the shell.

These slices only appear as circles if the observer is viewing them perpendicular to their plane. Any other angle of observation gives them the appearance of an ellipse.

A good example of the tunnel shown in Figure 13.2 can be seen on Chart XIII.C, which is the Dow Jones Industrial Average since the crash of 1987. The major declines shown on this chart were between the dates of 8/1987-10/1987, 7/1990-10/1990, 6/1992-10/1992, and 8/1994-11/1994. These elliptical declines were slices out of the growth spiral that took the form of a tunnel.⁶

Lesson XIV studies the growth spiral in the soybean market that originated at the 1977 low. This spiral took the form described in the preceding paragraphs and shown below in Figure 13.3.

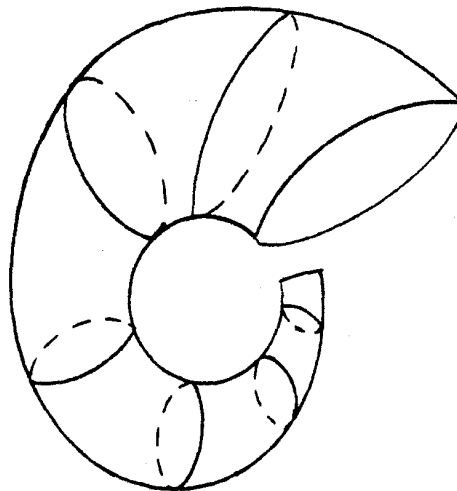

Figure 13.3
A Curved Tunnel Forms A Nautilus Shell

NON-EUCLIDEAN GEOMETRY

The fifth axiom of Euclid's *Elements* states,

"If two lines are intersected by a transversal in such a way that the sum of the degree measures of the two interior angles on one side of the transversal is less than 180° , then the two lines meet on that side of the transversal."

⁶ Appendix C examines the vectorial relationships between each of the "slices" of this growth spiral. Not only are these declines related to each other by the square root of two, but they are also spaced in price-time by this same relation.

CHART XIII.C

ELLIPTICAL SLICES FROM TUNNEL

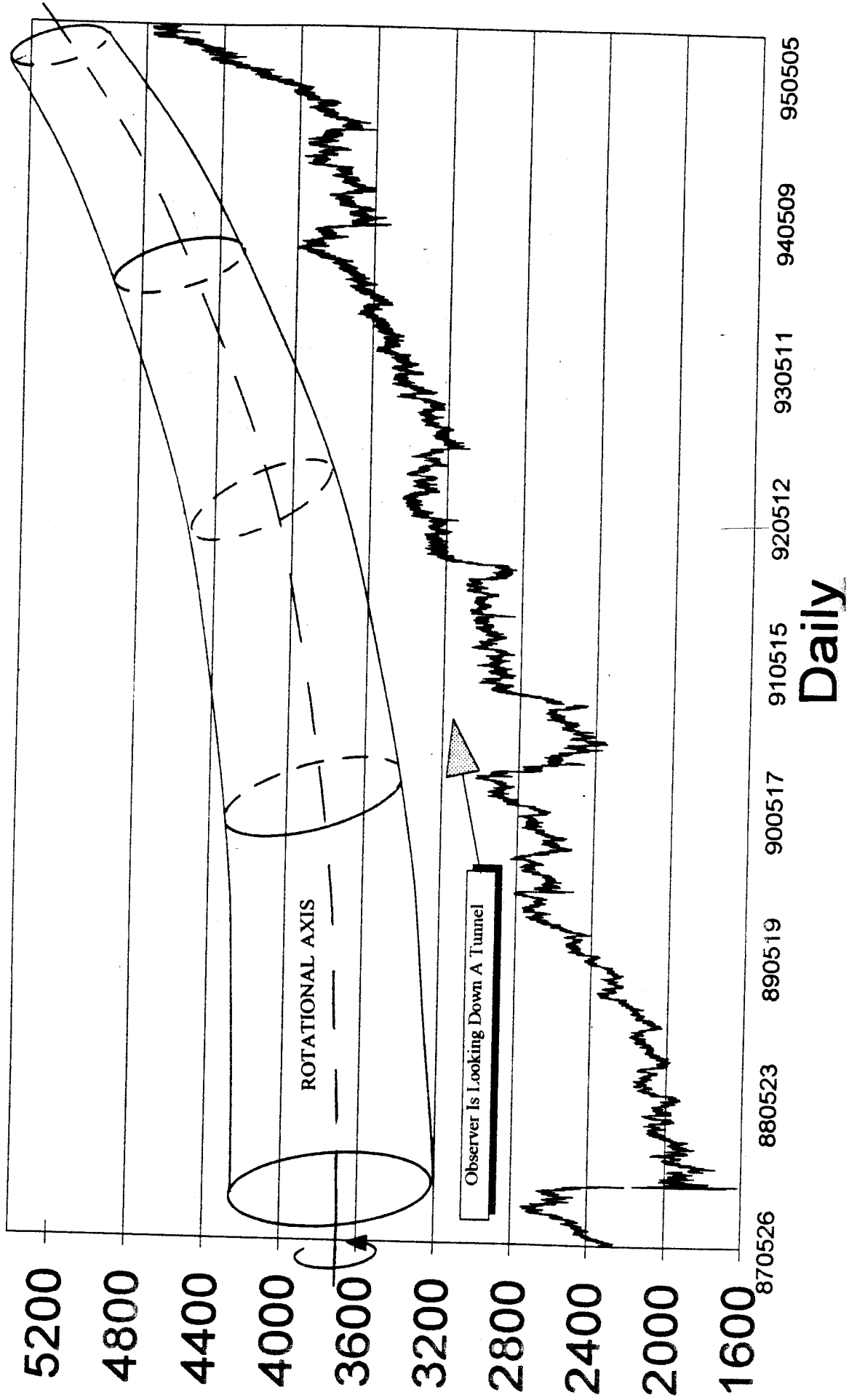

Pictorially, this can be seen in Figure 13.4 where the two parallel lines, AB and CD, are cut by a third line, EF, at right angles. Euclid's fifth axiom states that if the sum of the two interior angles equals 180° then the two lines, AB and CD, are parallel and never meet. According to Euclid, in order for AB and CD to meet at some point, the sum of the two interior angles must be less than 180° .

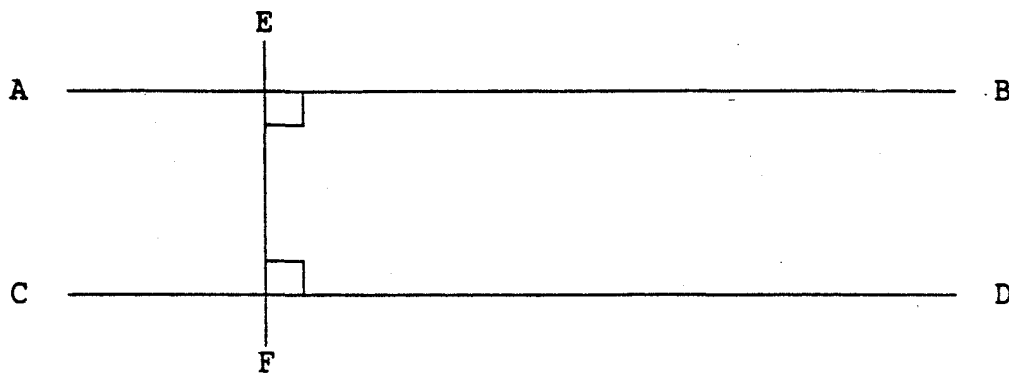

Figure 13.4
 Euclid's Fifth Axiom Concerning Parallel Lines:
 If EF Is Perpendicular To Both AB And CD,
 Then AB And CD Are Parallel And Never Meet.

Similarly, Euclidean geometry states that the sum of the three inner angles of a triangle always equals 180° , as shown in Figure 13.5. The triangle shown in this figure is equilateral and hence, its three inner angles are 60° .

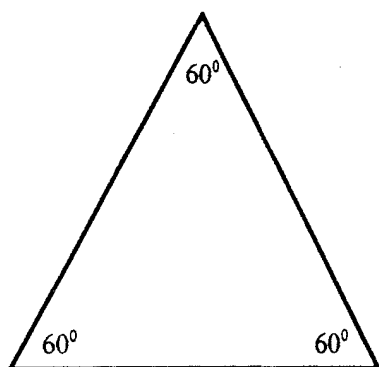

Figure 13.5
 Sum Of The Three Inner Angles Of A Triangle On A Plane Is 180°

The birth of non-Euclidean geometry (sometimes called hyperbolic geometry) arose from the fact that Euclid's fifth axiom breaks down when the surface containing the lines is not planar, but is curved. An illustration of this limitation of Euclidean geometry is shown in Figure 13.6 where two lines on the surface of a sphere are cut by a third line at right angles. This is the same configuration as the equatorial circle intersecting two meridian circles. Each of these circles appear as lines when viewed from their edge, as shown by the center line in Figure 13.1.b. The two lines in Figure 13.6 meet at the point labeled A, in contrast to the rules of Euclid's fifth axiom.

Similarly, when an equilateral triangle is defined on the surface of a sphere the sum of the three inner angles is a value greater than 180° , and as the size of the triangle increases, the sum of these inner angles also increases. Only when the size of the triangle is reduced to that approaching a point does the sum of the three inner angles approach 180° . Again, this is in contrast to Euclidean geometry.

The limitations of Euclidean geometry are important to financial market analysis because,

THE PROVEN CURVATURE OF TIME RESULTS IN PRICE-TIME UNFOLDING ON A NON-PLANAR SURFACE.⁷

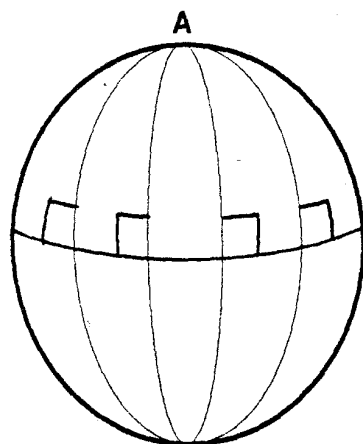

Figure 13.6

Meridian Circles Are Orthogonal To The Equatorial Circle, Even Though Meridian Circles Meet At Two Common Points At The North And South Poles.

⁷ Proof of this fact can be found by reviewing the scientific journals that have documented experiments since the nineteenth century proving the curvature of space-time.

Many people think that Einstein originated this concept, but the German scientist, Carl Friedrich Gauss, conducted experiments in an attempt to prove it nearly 100 years before Einstein wrote his Special Theory Of Relativity. Gauss put light sources on three mountain tops and tried to measure the inner angles of the triangle they formed in an attempt to prove that their sum was greater than 180° . His results were inconclusive because the instruments available to him at that time were very crude and could not make the measurements with the required accuracy. Because Gauss was as much a perfectionist as a brilliant scientist the details of this experiment were not published, but most likely he used a system of mirrors to reflect sun light. Gauss wrote letters to colleagues in 1817 discussing this concept and stating that he had already been pondering it for 30 years prior, since 1787.⁸ It is amazing that this type of scientific thinking was happening during the time of the French and American Revolutions.

—The curvilinear nature of price-time explains the difficulty in trying to determine with consistency the angles between PTVs™ when measured on a two-dimensional chart, especially when three or more are used to form a polygon. The reader may have noticed that the sum of the interior angles of equilateral triangles formed in price-time rarely equal 180° .

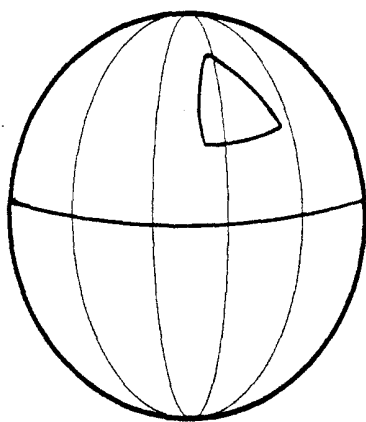

Figure 13.7
The Sum Of The Three Inner Angles Of A Triangle
On The Surface Of A Sphere Is Greater Than 180°

⁸ Reference Wolfe, H.E. 1945, *Introduction to Non-Euclidean Geometry*, New York: Holt, Rinehart and Winston.

WWW.FOREX-WAREZ.COM
ANDREYBBRY@GMAIL.COM SKYPE: ANDREYBBRY

Motion is another aspect of hyperbolic geometry not found in Euclidean geometry, because Euclidean geometry is inherently static. Even when the motion of a point is used to define a series of points, such as when a point is rotated around a center to create a circle, the final form is static.

This limitation of static geometry can be understood by placing an object into motion. Euclidean geometry can describe the location of this point at any single moment by giving its x, y, z coordinates. However, it does not tell **WHEN** this point was at these coordinates, nor when to expect it to be at any point in the future within this coordinate system. This type of geometry is fine for many everyday applications, but is little help when studying a system that is dynamic by nature, such as financial markets. It was from this lacking in Euclidean geometry that mathematicians in the early nineteenth century introduced the concept of the fourth dimension with the standard x, y, z coordinates and time as the fourth dimension.

Since prices change as a function of time, financial markets are dynamic systems requiring application of non-Euclidean geometry. This is essential because markets can not be accurately modeled within the limitations of a static analysis on a two-dimensional chart.

CURVILINEAR PRICE-TIME MOTION IN THE SOYBEAN MARKET

It has already been explained that the same resistance line that stopped the advances at the 1920 and 1948 tops also provided the support at the 1975 bottom. However, Chart XIII.A shows that the decline into the 10/1986 bottom at 455 did not quite reach this support line because a **CURVILINEAR** trend arc arrested that decline before it reached the long-term line. This resistance arc originated at the 6/1973 top and also stopped the advance into the 10/1974 top. When this arc was penetrated in 1977 it became the support arc that defined the limits of the declines into the 9/1978, 4/1980, 10/1982, and 10/1986 bottoms. Arcs such as this are **PRIMARY SUPPORT ARCS**, which are characteristically associated with the points that define major bottoms and reverse the direction of the movement.

In contrast to the primary support arc is the **SECONDARY SUPPORT ARC**, which provides temporary support but is ultimately breached. A good example of a secondary support arc can be seen on Chart XIII.D, which is a closer view of the market since 1969. The secondary support arc is shown as the dashed arc directly above the primary support arc. The areas where the price-time action encountered the secondary arc are circled. Notice that the action paused on this arc for a few months, but finally fell down to the primary support arc. The points where the action did not penetrate the secondary arc have occurred more recently at the bottoms in 10/1989, 7/1991, 10/1992, and 10/1994. The action did not drop below the secondary support arc at these locations because the primary support arc had itself fallen below the long-

term linear support line in 1986, effectively eliminating the dominance of the primary support arc.

Although some analysts notice how the bottoms labeled B, C, D, and E follow a smooth curvilinear arc, few notice the second, less dominant, arc shown on this chart as a dashed curve.

Notice that as smaller sections of an arc are looked at they appear to be more linear. For example, the bottoms in 10/1989, 7/1991, 10/1992, and 10/1994 appear to be lying on a straight line, but this has been shown to be a small slice out of a gradually changing arc.

An example of a **PRIMARY RESISTANCE ARC** is shown on Chart XIII.D, which defined the tops in 5/1978, 6/1979, 11/1980, 9/1983, and 7/1988.

The first arc moving down from the top in 6/1973 crossed the arc moving up from the 12/1975 bottom in 1977. These two arcs contained the tops and bottoms after that date. And since these two arcs were moving away from each other, the price swings became progressively larger as time progressed, effectively defining an **EXPANDING GROWTH PROCESS**.

Two other examples of curvilinear support and resistance are shown on Chart XIII.E. Between 1919 and 1940 the two arcs, LM and LN, stopped the advances. Similarly, between 1947 and 1960 the two arcs, WX and XA, defined each top.

Notice that the time length of these two quarter-spheres are Fibonacci numbers, the first lasted 21 years from 1919 to 1940 and the second lasted 13 years from 1948 to 1961. The next number in this contracting tunnel, which extended from 1913 to 1969, is 8 years and defined the time interval between the bottom in 10/1961 and 10/1969. Similarly, it was 5 years from the bottom in 10/1961 to the top in 1966 and 3 years from the top in 1966 to the final bottom in 1969. This established the decaying Fibonacci time intervals within this spiral from 1919 to 1969 as follows:

21, 13, 8, 5, 3 years

The importance of these yearly Fibonacci time intervals will be further studied in the following lessons of this book, where it will be shown that the growth spiral that is currently unfolding is also following this number series.

The discussion in this section, and in those preceding it, has demonstrated the curvilinear nature of price-time. This curvature is seen as a series of support and resistance arcs with varying levels of strength. The appearance of motion causing these curves on a two-dimensional page can be described as follows:

CHART XIII.D

Non-Linear Support & Resistance Arcs

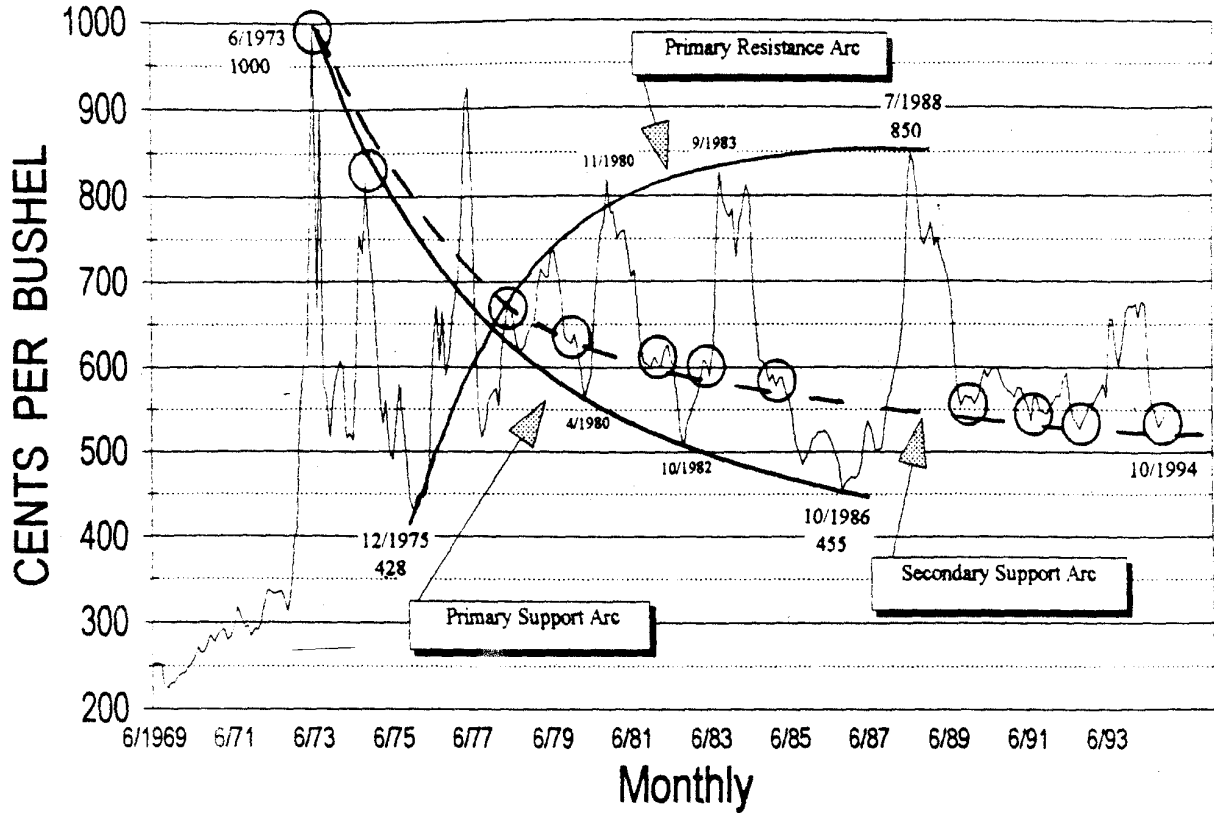
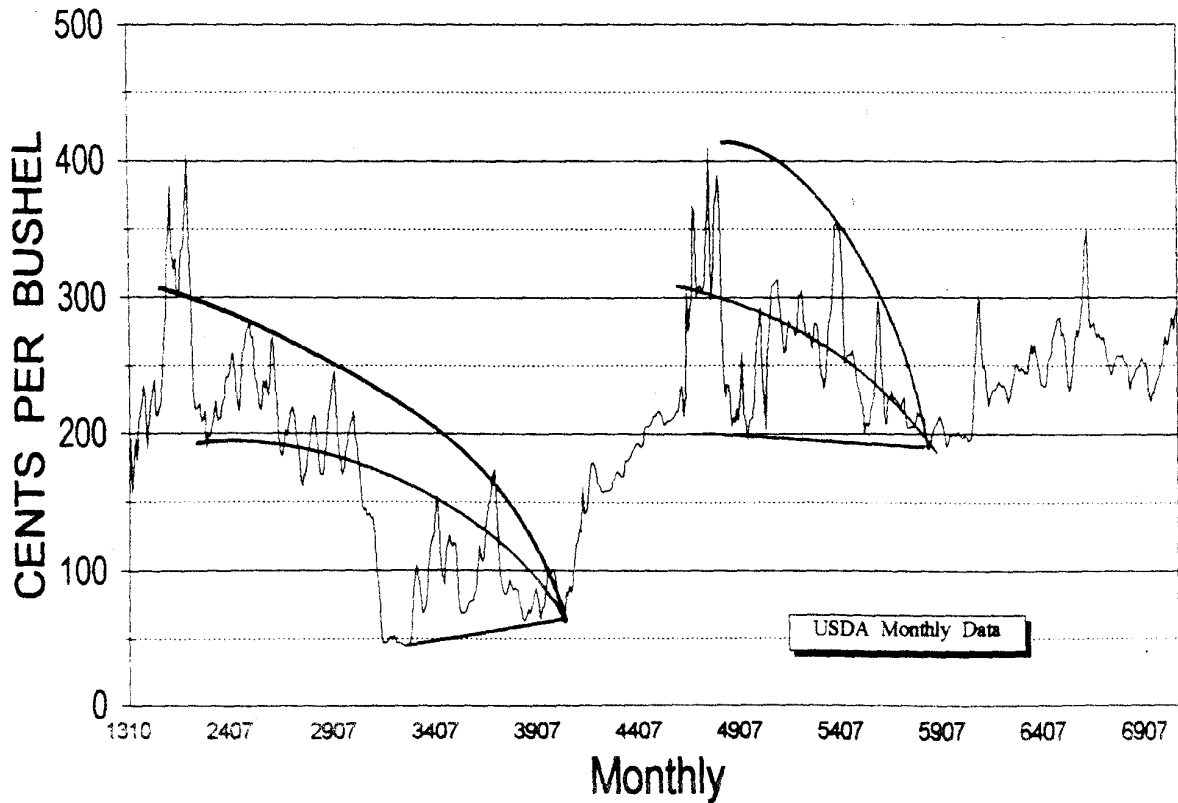

CHART XIII.E

CURVILINEAR SUPPORT AND RESISTANCE



PRICE-TIME SUPPORT AND RESISTANCE ARCS ARE FORMED BY A SERIES OF CIRCLES ROTATING AROUND A COMMON CENTRAL AXIS.

These circles typically appear as ellipses because the viewer's angle is not perpendicular to the surface of the circle.

The next section will further advance this concept by showing how spheres placed into non-linear motion describe the process of unfolding that is recorded on a two-dimensional chart. These spheres revolve around a center creating a toroidal shape with the path they sweep out, similar to that defined by the planets as they revolve around the sun.

A REVOLVED SPHERE CREATES A TORUS

—If the process of using motion to create progressively more complex geometric forms is continued by placing a sphere into linear motion, a cylindrical shape (tunnel) is formed, as shown in Figure 13.8.a.⁹ Figure 13.2 showed that a planar slice out of this tunnel is a circle with its center the same as the center of the tunnel. In other words, the central axis of the tunnel is the rotational axis that defined the circle shown in Figure 13.1.a.

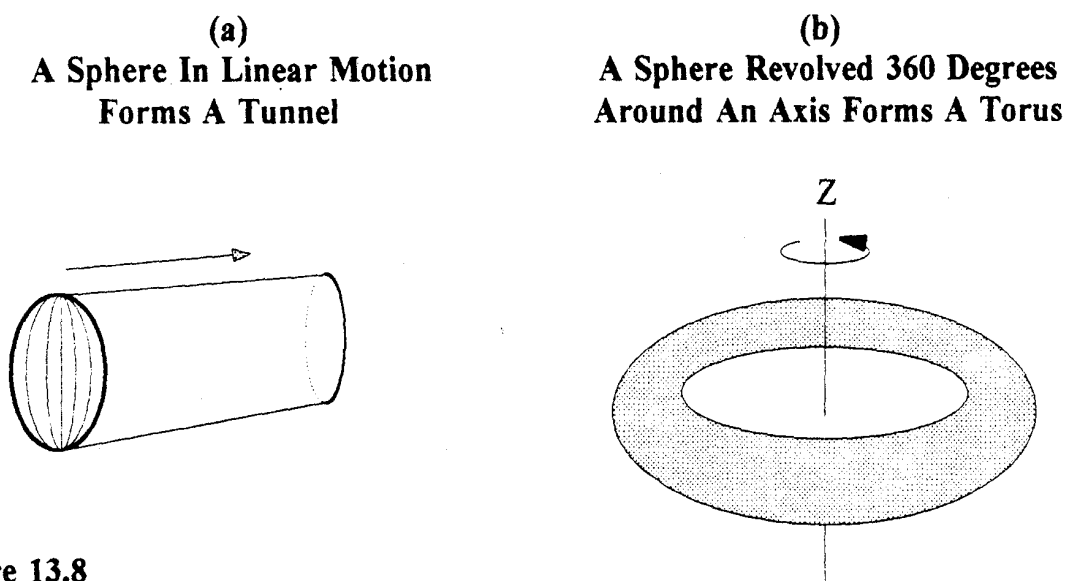

Figure 13.8
A Sphere Revolved 360 Degrees Forms A Torus

⁹ In financial markets the "motion" referred to here is the recording of time along the two-dimensional price-time chart. This was discussed in Lesson X in *Four-Dimensional Stock Market Structures And Cycles*.

The narrowing appearance of the tunnel in Figure 13.8.a is the result of one end of the tunnel being further away from the observer than the other.

If the moving sphere does not follow a straight line, but rather, is revolved around a third axis, the sphere sweeps out a torus¹⁰. This is shown in Figure 13.8.b where the axis of revolution is labeled "Z".

The reader can understand this dynamic system by seeing a rotating vector with its origin at the center of the tunnel of the torus. The tip of this rotating vector defines the surface of the tunnel as the circle revolves around the central axis of the torus ("Z" in Figure 13.8.b). Therefore,

THE DIRECTION OF MOTION OF THE CIRCLE AS IT MOVES THROUGH THE TUNNEL OF THE TORUS IS PARALLEL TO THE AXIS OF ROTATION OF THE CIRCLE, AS SHOWN IN FIGURE 13.1.A.

In summary, the sequence of motions used to create the torus are identical to those found in the rotations and revolutions of the planets, which can be summarized as follows:

- (1) The tip of a rotating vector of constant length defines a circle.
- (2) A circle rotated around a second axis sweeps out a sphere.
- (3) A sphere placed into linear motion sweeps out a tunnel. This appearance of motion is caused by the sequential recording of time along the x-axis of the chart.
- (4) A sphere placed into circular motion, such that it is revolved 360° around a center, sweeps out a torus.

THE TORUS IN THE DOW JONES INDUSTRIAL AVERAGE

An example of a torus can be seen in the Dow Jones Industrial Average, from 1966 to 1982. This section of market was explained in detail in *Four-Dimensional Stock Market Structures And Cycles* and is shown on Chart XIII.F with the torus overlaid on the graph.

¹⁰ "Torus" is the mathematical term for a donut shaped object.

CHART XIII.F

TORUS IN DJIA (1966 - 1982)

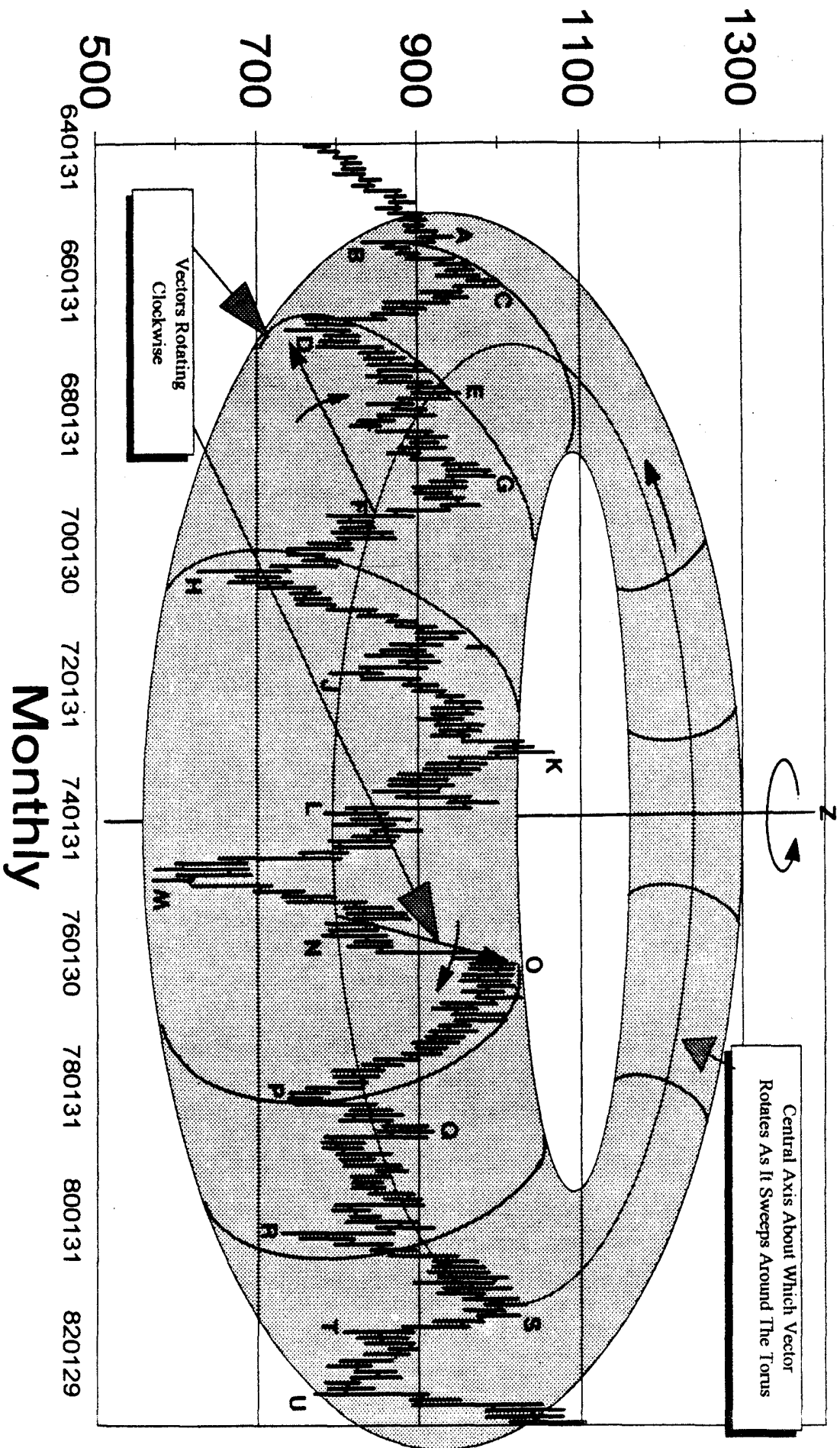

It is understandably difficult to draw a torus on a two-dimensional price-time chart that accurately represents the motion. This effort is similar to taking a toroidal shaped balloon with price swings drawn on its surface and trying to represent that three-dimensional form on a two-dimensional page. And complicating the problem even further, is the fact that the price-time motion does not always follow along the surface of the torus. However, to help visually understand the rotation of the vectors, Chart XIII.F is acceptable if the reader is aware of the two-dimensional limitations of the chart.

There are two rotational axes shown on Chart XIII.F. The axis in the center is labeled "Z" and defines the circumference of the torus. It is this central axis that creates the appearance of motion across the chart from left to right. The second rotational axis shown on the chart is the ellipse drawn in the center of the "tunnel" part of the torus. Although this axis is shown as an ellipse, it is actually a circle because the points along its circumference are defined by a constant distance from the central axis, Z.¹¹ This ellipse is the axis about which the vectors, such as DF and NO, rotate in a clockwise direction. Point F lies directly on the rotational axis in the direct center of the tunnel. As vector DF rotated clockwise, it defined the points D, E, and G on the outside perimeter of the tunnel. Similarly, points A and C are on the outside perimeter of the tunnel.

The bottom in 1974 is the part of the torus closest to the observer, while those on the two ends, in 1966 and 1980, are furthest away. Notice that when the action passed in front of the observer at its closest point at M, the vectors gave the false appearance of reversing their direction of rotation. This can be seen by placing a pencil parallel to vector DF and rotating it in a clockwise direction as it is moved across the page from left to right. When point M is passed the rotation of the pencil appears to change to a counterclockwise direction. However, this is not what actually happened. Both vectors DF and NO rotated in a clockwise direction. The appearance of rotational shifting was caused because between points A and M the observer is looking down the tunnel from right to left, and after point M the observer is looking down the tunnel from left to right. This clockwise rotation caused NO to sweep from point O to point P with the action following the outsider perimeter of the tunnel.

This tunnel should be carefully studied, specifically where the action followed the outside perimeter and where the ellipse defining the rotational axis was encountered, such as at points F, J, L, N, and Q through S.

¹¹ This is Euclid's Postulate III, which established the definition of the circle.

THE TORUS IN THE SOYBEAN MARKET

The rotational motion described above is not limited to any particular market, nor to any time frame, allowing the analyst to identify its form on five minute charts, as well as on the monthly and yearly.

THE TORUS OCCURS IN ALL FINANCIAL MARKETS AND IN ALL TIME FRAMES.

Chart XIII.A shows the growth spiral in the cash soybean market from 1913 to 1969. On a two-dimensional price-time chart the containment perimeter of this growth spiral took the form of a tunnel. The top of this tunnel was defined by the long-term trendline connecting the 1920 and 1948 tops, and was penetrated in 2/1973 when the Paris Peace Accords was signed, officially ending American involvement in the Vietnam War. When the price-time action broke out of this torus it moved into the next larger growth spiral at a higher energy level. Notice that, since breaking into the new torus, price levels have not dropped back below the long-term resistance line.

The ordering of the increasing magnitude of these growth spirals (the one from 1913 to 1969 and the one after 1969) takes the form of two tori, one larger than the other. The action from 1913 to 1969 was contained within a section of the smaller torus, which gave the appearance of the tunnel described above. Figure 13.8 showed that a two-dimensional chart gives the appearance of a tunnel extending away from the observer when the growth spiral is contracting. This phenomenon can be seen on Chart XIII.A where the growth spiral appears to be closer to the observer in 1932 than it was in 1969, i.e., the growth spiral appeared to be contracting as time progressed.

THE TORUS IN THE LIVE CATTLE MARKET

Another example of the torus can be seen in the live cattle market, shown on Chart XIII.G. The circled areas on this chart are similar to those described above in the DJIA and soybeans. That is, they represent a section of a torus.

The section labeled "B" spanned the 1980 to 1985 time period and is enlarged on the lower part of this graph.¹² This time period in the cattle market was very similar in form to the 1978-1994 soybean market and to the 1966-1982 Dow Jones Industrial Average. On this graph, the bottom in October, 1982 is closest to the

¹² Notice that this market follows a clear ten month cycle. That is, five month of increasing prices followed by five months of decline. This cycle is correlated with the Jupiter-Saturn 15° axes described in *Four-Dimensional Stock Market Structures And Cycles* and shows how every market has its own specific resonant frequency that is most dominant.

CHART XIII.G

TORUS IN LIVE CATTLE

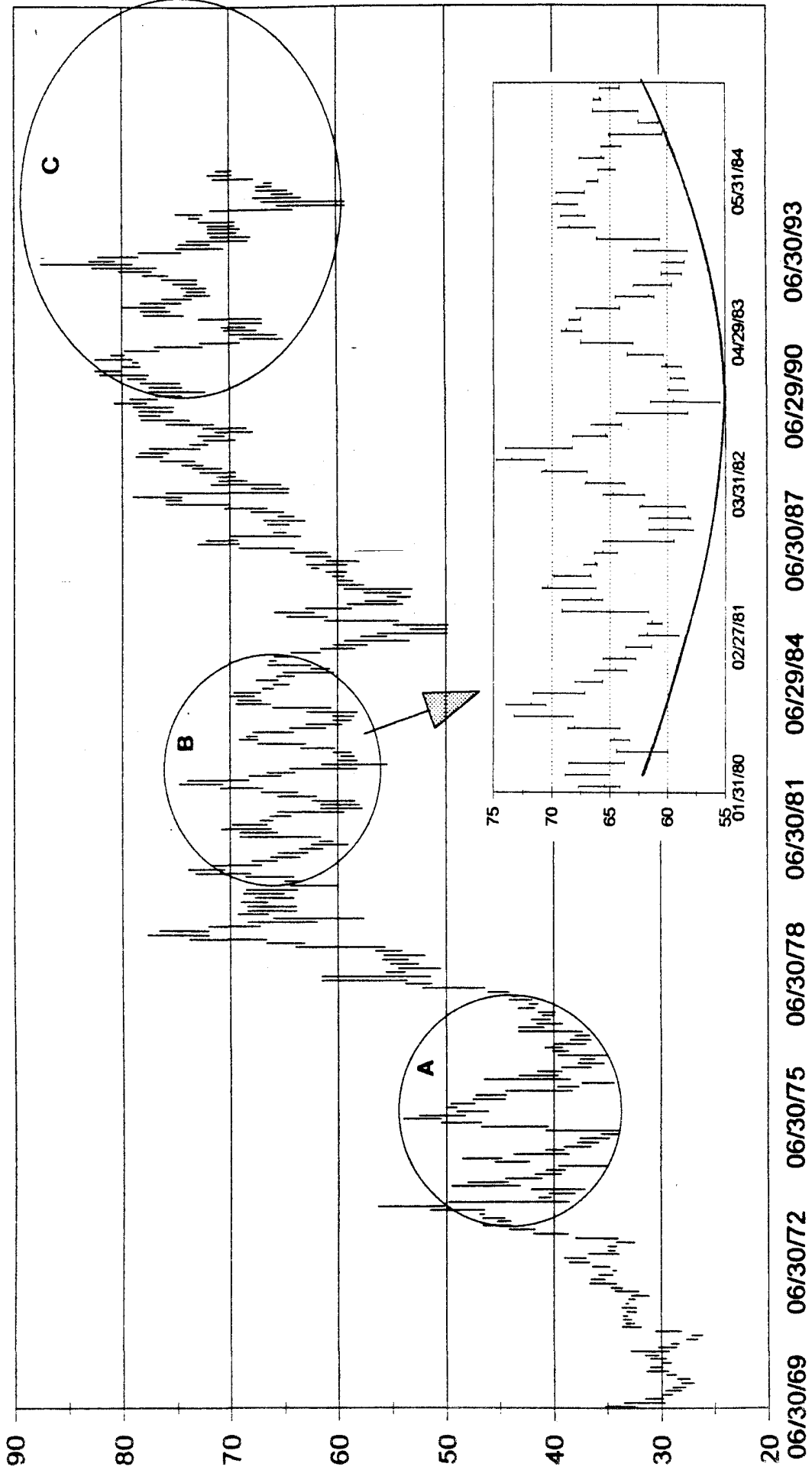

Monthly

observer, while the points on the two ends are furthest away. The bottom in 10/1982 in this torus is similar to the bottom in the DJIA in 1974.

The section labeled "C" on Chart XIII.G is similar to "B", except that it is larger.

CONCLUSION

It is difficult to open any book on market analysis without coming across some variation of linear support and resistance that traders have known about for years. However, what is not commonly known about trend lines is that they only have applicability at certain locations within price-time. For example, when the action is following the major axis of an ellipse, the motion appears to be linear. Or, when the action is contained by a gradually changing arc, and only a small section of that arc is seen, the motion again appears to be linear. However, when movements within price-time are contained by the perimeter of an ellipse the motion follows a curvilinear trend.

HYPERBOLIC MOTION REQUIRES THE USE OF NON-EUCLIDEAN GEOMETRY BECAUSE THE RULES USED IN EUCLIDEAN GEOMETRY NO LONGER APPLY.

A support or resistance arc is either primary or secondary, depending on its level of strength and tendency to either reverse the direction of a movement or cause a temporary congestion area within an ongoing trend. Primary arcs are the most important because they are associated with the major tops and bottoms, consequently, they identify when the movement has finally completed.

It is also important to know the location of the secondary arcs because prices can pause on them for months or years before finally continuing their trend on to the stronger primary arcs.

Analysts who would like to study a topic related to support and resistance arcs should know that it is possible to calculate their strength by measuring the energy needed to break through them. To measure the force necessary to do this the same techniques are used as with any other natural system. Some of the relevant items needed for the calculation of these forces are the velocity of the movement, the inertia, the open interest, and the rate of change of volume. Armed with this information, the analyst can apply Newton's Laws to find the force necessary to break through these areas.

This lesson showed that the primary and secondary arcs come together at a common point that typically is associated with a major point of force, such as the all-time high in 6/1973 or the major low in 11/1958. This configuration is the result of a series of radii vectors sweeping out meridian circles. The curvilinear appearance of the motion is caused by the recording of price-time changes as a function of time, which Einstein's theories have proven to be curvilinear.

Remember, the circle, sphere, and torus define the **CURVILINEAR** forms created by vectorial rotation. This is not the same concept as the linear geometric structures defined by the lattice of points of force in price-time, as described in *Four-Dimensional Stock Market Structures And Cycles*. For example, the torus shown on Chart XIII.F, containing the 1966 - 1982 DJIA, is the top of the cube from 1899 and the bottom of the cube from 1966. However, within that square the motion was curvilinear.¹³

Figure 3.1 in *Four-Dimensional Stock Market Structures And Cycles* showed a side view of a conical helix.¹⁴ When the curved line that describes this conical helix is used as a rotational axis, such as the ellipse shown on Chart XIII.F, a form similar to a series of expanding tori is created. These tori increase in size as growth proceeds and the energy level increases.

EACH TORUS REPRESENTS ONE LEVEL OF THE GROWTH PROCESS. WHEN THAT SPIRAL IS COMPLETE THE ACTION MOVES INTO THE NEXT LARGER TORUS.

As price-time unfolds, the form that is taken by these tori is that of one torus stacked on top of another, as shown in Figure 13.9. Different views of this figure were presented in *Four-Dimensional Stock Market Structures And Cycles* in Figures 2.2.a, 3.1, and 4.3.

A good example of these expanding tori can be seen in the long-term chart of the soybean market shown on Chart XIII.A. The section from 1913 to 1969 was in the smaller torus. After 1969, the energy level increased and the action moved into the next larger torus that is still unfolding.

¹³ This is the same concept referred to by W.D. Gann when he said, "within the circle forms the triangle and the square."

¹⁴ This figure and its relationship to a series of stacked circles should be reviewed.

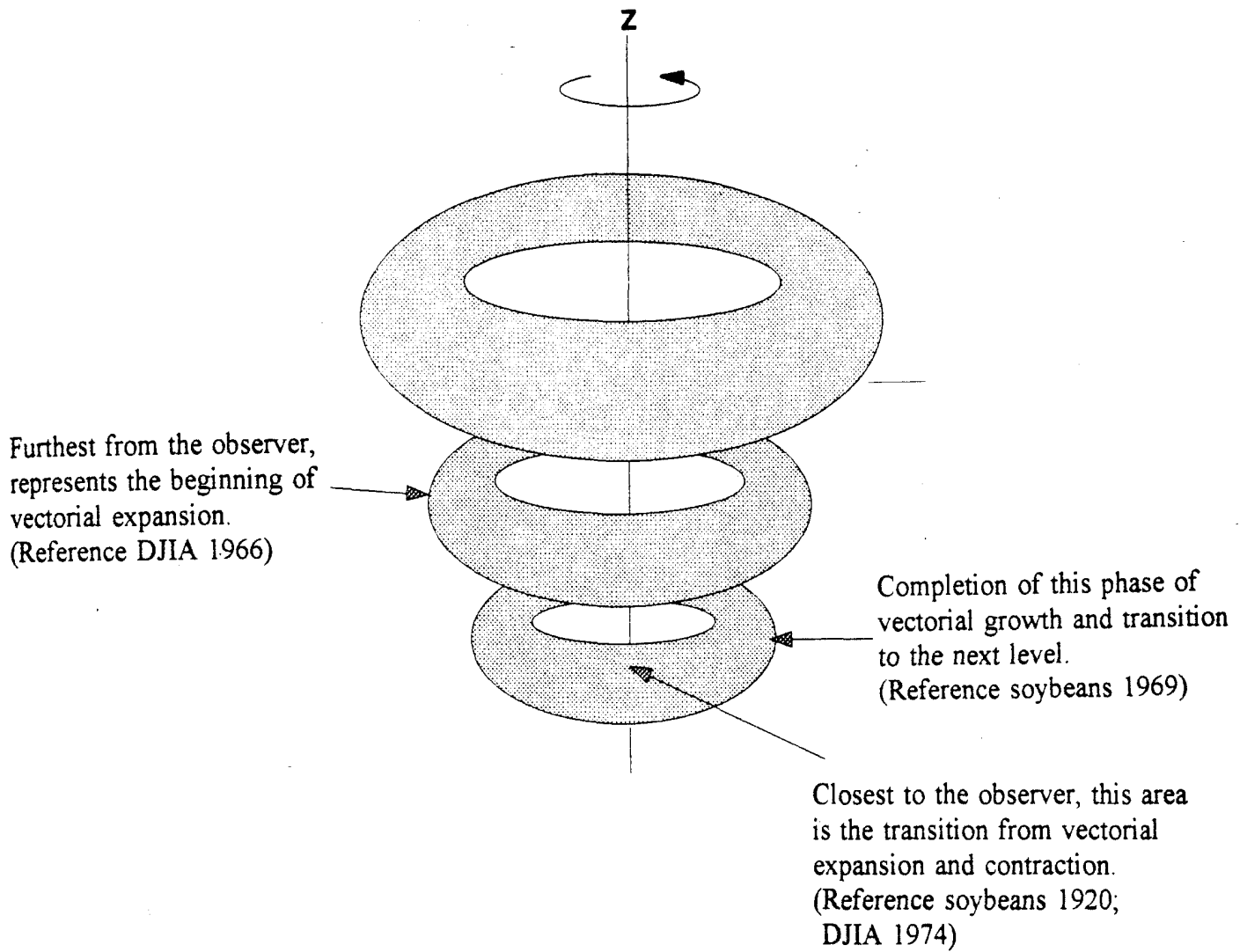

Figure 13.9
Tori Increase In Size With Increasing Energy Levels

LESSON XIV

QUANTUM ENERGY LEVELS OF FREELY TRADED MARKETS

The atom is the last descendant of the concept of the soul.

... Friedrich Nietzsche (1844)

INTRODUCTION

The first volume of this series, *Square Of Twelve*, measured PTVs™ in the soybean market beginning in 1913 using monthly cash data from the USDA. Also, the daily cash data from Decatur, Illinois was studied, as was the May futures contract. These PTVs™ were shown to be defined by simple mathematical relationships to the square of twelve.

This lesson expands on the material presented in *Square Of Twelve* by showing that when the magnitudes of these PTVs™ are compared a perfect order, based on a simple number series, presents itself. It will be shown that this number series defines the expansion (or contraction) of successive vectors within the price-time growth spiral and that it is the same number series used in "modern" physics to define increasing quantum energy levels of the atom as the electron shells are filled.

This lesson goes no further into quantum theory than is necessary for an understanding of its applicability to financial markets. Even those who feel uncomfortable with science should have no problem understanding the following material because it is kept very basic.

First, a brief overview of the theory of atomic structure is provided, then the applicability of this physical law to the soybean market is studied.

The topic of quantum energy levels should be studied in greater detail by serious market analysts, because the material presented in this writing only touches on its basic concepts. Most college level chemistry and physics text books cover this subject.

W.D. Gann subtly implied in his book *How To Make Profits In Commodities* that he was aware of the changing energy levels of markets. In fact, one of the charts that he printed in that book showed the price scale changing half way up the chart to a value twice that before the change. This implies that Gann was using the concept of octaves (doubling) to his price analysis. However, his written work only applied this concept to the single dimension of price.

This work goes well beyond anything presented by any other analyst and applies quantum energy levels to PTVs™, effectively isolating points of force in price-time with an accuracy and predictability never before published. As the author has stated many times in the past, few of the realities presented in this lesson would be seen

without use of the PTV™. After studying this lesson, any doubts the reader may still have about the efficacy of PTV™ analysis should be put to rest.

STRUCTURE OF THE ATOM

Quantum Theory is based on a postulate made by Max Plank at the German Physical Society on December 14, 1900, which states that radiant energy can not be emitted or absorbed continuously. Rather, it exists in "packets" called "light quanta". This means that as long as an electron orbits the nucleus of the atom in a constant state no energy is absorbed or emitted from the system. If an external stimulus causes the electron to move to a different energy state the energy emitted or absorbed must equal the difference between the energy levels of the two states. What this means is that the energy levels between two states are not continuous. That is, the electron jumps from one energy level to another instead of smoothly transferring between them. The emitted energy takes the form of light at a specific frequency.

After Plank presented his postulate, it became the basis for many physicist's work including Louis De Broglie's *Wave-Particle Duality*, Schrodinger's *Wave Mechanics*, Bohr's *Atomic Model*, Heisenberg's *Uncertainty Principle*, and Einstein's *Theories of Relativity*.

Around the year 1924, modern quantum mechanics replaced the Bohr model as the generally accepted atomic model by stating that the location of the electron existed only as a "probability" and not at any specific location. However, when these probabilities are mathematically worked out they very closely describe locations for the electron given by the Bohr model.

There are four important definitions used in quantum theory that will be helpful in understanding the applicability of this science to financial market timing.

- (1) The **Principal Quantum Number** defines the average distance of the electron from the nucleus. It is defined by the integers 1, 2, 3, 4, ..., with the electrons closest to the nucleus in shell number 1 and those furthest from the nucleus in shells of increasing quantum number. Therefore, electrons in principal quantum number one are at the lowest energy level.
- (2) The **Orbital Quantum Number** designates the individual regions within the principal quantum levels described above.

EACH ORBITAL CAN ACCOMMODATE A MAXIMUM OF TWO ELECTRONS.

This fact must be remembered because it will later be shown that the extent of vectorial expansion within the growth spiral of soybeans is defined by this same principle.

The names of the orbitals were taken from spectroscopy. They are called:

- "s" for sharp
- "p" for principal
- "d" for diffuse
- "f" for fundamental

Orbitals within a given subgroup represent equivalent energy levels, but have different orientations in space.

- (3) The **Orbital Magnetic Quantum Number** defines the magnetic field associated with the electron. Because the electron is a moving charged particle, it has a magnetic field.
- (4) The **Spin Magnetic Quantum Number** describes the spin of the electron. Since electrons appear to be tiny magnets, this number defines the orientation of that magnet. There are only two possibilities for this value, clockwise and counterclockwise. If two electrons are spinning in the same direction they can not occupy the same orbital. Therefore, each orbital has a maximum of two electrons, which have opposite spins.

The orbitals described above are shown in Table 14.1. Each circle in this table represents an electron. Notice that the electrons appear in pairs.

Table 14.1 should be carefully studied. It shows that as the quantum level of the atom increases the distribution of pairs of electrons follows a sequence of odd integers: 1, 3, 5, 7. That is, the "s" orbital has a maximum of two electrons or one pair. When this orbital is filled with two electrons the next electron moves into the "p" orbital, which can hold a maximum of six electrons or three pairs. Next, the electrons move into the "d" orbital, which holds a maximum of ten electrons or five pairs. And finally the "f" orbital fills with a maximum of fourteen electrons or seven pairs.

The number of electrons within the orbitals are summarized below.

s	-	2 electrons (1 pair)
p	-	6 electrons (3 pairs)
d	-	10 electrons (5 pairs)
f	-	14 electrons (7 pairs)

Table 14.1
Orbital Available To Electrons In Principal Quantum Levels
 ("n" are Principal Quantum Levels; "s", "p", "d", "f" Are Orbitals)

n	s	p	d	f
1	○ ○			
2	○ ○	○ ○ ○ ○ ○ ○		
3	○ ○	○ ○ ○ ○ ○ ○	○ ○ ○ ○ ○ ○ ○ ○ ○ ○	
4	○ ○	○ ○ ○ ○ ○ ○	○ ○ ○ ○ ○ ○ ○ ○ ○ ○	○ ○ ○ ○ ○ ○ ○ ○ ○ ○

And since these electrons appear in pairs when the orbital is filled, the above number sequence is:

1, 3, 5, 7

To summarize Table 14.1:

AS THE ORBITALS OF THE ATOM FILL, THE NUMBER OF PAIRS OF ELECTRONS WITHIN THOSE ORBITALS FOLLOWS THE SEQUENCE OF ODD INTEGERS.¹⁵

The next section will demonstrate the applicability of quantum theory to financial market analysis where it will be shown that,

VECTORIAL EXPANSION WITHIN THE SOYBEAN MARKET FOLLOWS THE SEQUENCE OF ODD INTEGERS, AS DEFINED BY THE LAWS OF QUANTUM THEORY.

¹⁵ It is recommended that the reader now reference his chemistry or physics books concerning the structure of the periodic chart of the elements, which describes the periodic recurrence of the physical properties of the elements as the atomic number increases.

The following analysis uses the square of twelve as the elemental unit of measurement, much as the electron is used as the "packet of energy" in modern quantum theory.

QUANTUM ENERGY LEVELS OF THE SOYBEAN MARKET

Figure 5.7 in *Four-Dimensional Stock Market Structures And Cycles* showed that the vectorial relationships in the 1966-1982 square in the stock market were defined by a three-dimensional view of a "tunnel" with a sequence of contracting (or expanding if viewed from the opposite end) squares inscribed within it. That figure is shown below in Figure 14.1.

The sequence of expanding circles and squares shown in Figure 14.1 are connected at a single point labeled "A". From this common point, a progression of PTVs™ define the size of subsequent circles (and squares) as each phase of the growth process completes and the magnitude of the next turn of the spiral is established.

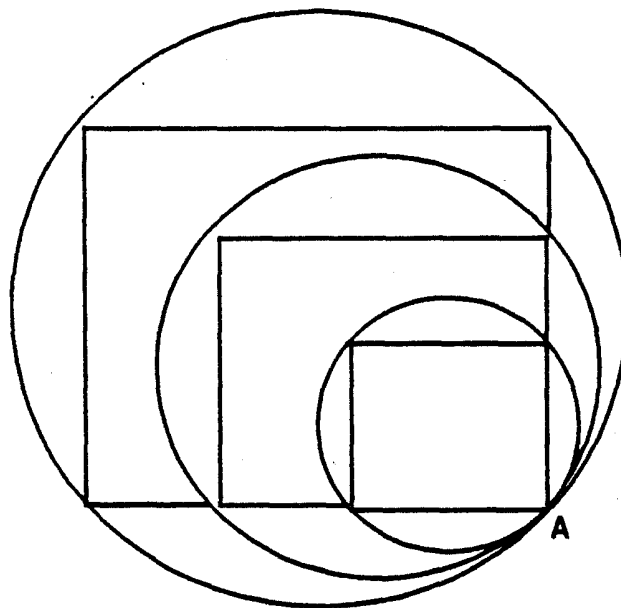

Figure 14.1
 Vectorial Expansion In Price-Time From A Common Point Of Origin
 (See Figure 5.7 in *Four-Dimensional Stock Market Structures And Cycles*)

WWW.FOREX-WAREZ.COM
ANDREYBBRY@GMAIL.COM SKYPE: ANDREYBBRY

This can be seen in the cash soybean market where the vectorial expansion of the PTVs™ presented in *Square Of Twelve* was defined by an increasing number series originating at the point of force in February, 1920.¹⁶

Although Figure 5.7 in *Four-Dimensional Stock Market Structures And Cycles* showed a PTV™ expansion defined by the square root of two,

**VECTORIAL EXPANSION IN THE SOYBEAN MARKET, WHICH
DEFINES THE MAGNITUDE OF SUCCESSIVE TURNS IN THE
GROWTH SPIRAL, IS DEFINED BY THE SQUARE OF TWELVE.**

For example, Chart XIV.A shows the vectorial expansion in the soybean market from the first major turning point in February, 1920 to the end of the growth spiral in October, 1969. The data for the PTVs™ shown on Chart XIV.A are contained within Table 14.2.

Although DE did not originate in February, 1920, it was included in Table 14.2 because December, 1932 was also at the mouth of the tunnel, at the bottom. This tunnel was shown on Chart XIII.A and was described in Lesson XIII.

Table 14.2
Vectorial Expansion Across The Growth Spiral
From February, 1920 To October, 1969
(Data Recorded By USDA - See Chart XIV.A)

Price-Time Radius Vector™	Date of Low	PTV™ Price Low	Date of High	PTV™ Price High	Time Change in Weeks	Price Change in Cents	Vector Value (PTV™)
DE	12/1932	44	1/1948	411	784	367	865.6
BD	2/1920	405	1/1948	411	1452	6	1452
BE	11/1958	189	2/1920	405	2015	216	2026
BH	10/1969	223	2/1920	405	2583	182	2589

¹⁶ W.D. Gann said in both his *Master Course For Commodities* and *How To Make Profits In Commodities* to begin time cycle counts from this point in February, 1920. He also said to use CASH values.

CHART XIV.A

QUANTUM ENERGY LEVELS (1920 - 1969)

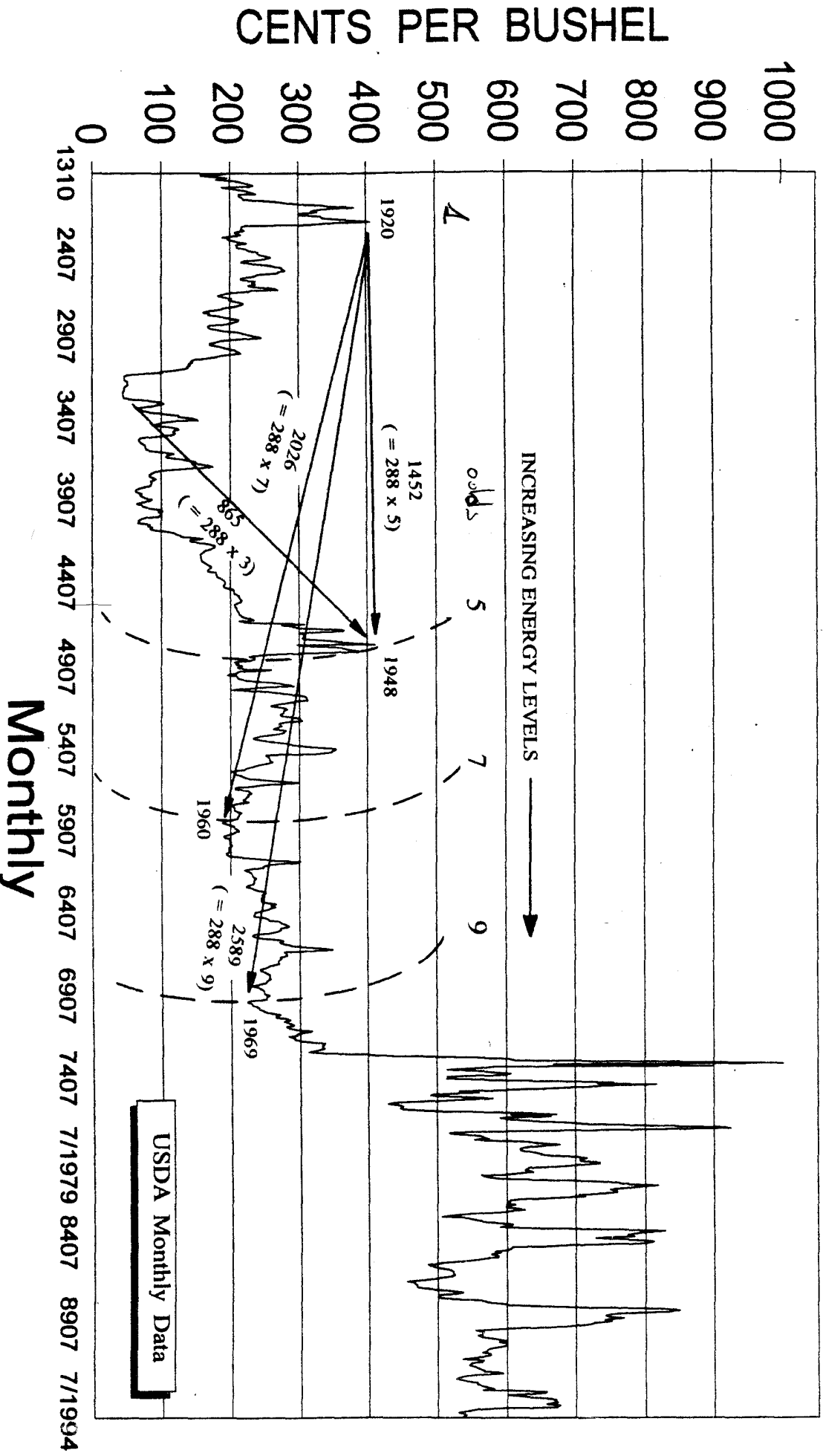

Table 14.3 summarizes the quantum energy levels within this growth spiral. Column four of this table shows that the PTVs™ extending from the mouth of the tunnel followed the second square of twelve multiplied by the sequence of odd integers: 3, 5, 7, 9.¹⁷

THIS IS THE SAME NUMBER SERIES SHOWN IN TABLE 14.1 DESCRIBING THE ORBITALS AVAILABLE TO ELECTRONS IN THE ATOM.

As mentioned earlier, the elemental unit of measurement in the soybean market is the square of twelve, and the atomic model uses electrons.

As time progressed, these energy shells defined the spacing from the mouth of the tunnel to major points of force within price-time. These shells coincided with the following turning points:

energy shell 3	top in 1/1948
energy shell 5	top in 1/1948
energy shell 7	bottom in 9/1959
energy shell 9	end of the growth spiral in 10/1969

Table 14.3
Quantum Energy Levels In The Vectorial Expansion
Measured From The Opening Of The 1913-1969 Tunnel

Price-Time Radius Vector™	Measured Value Of PTV™	Corresponding Square Of Twelve	Measured Value Of PTV™ Divided By Second Square Of Twelve (288)
DE	865.6	864 = 288 x 3	$\frac{865}{288} = 3.00$
BD	1452	1440 = 288 x 5	$\frac{1452}{288} = 5.04$
BE	2026	2016 = 288 x 7	$\frac{2026}{288} = 7.03$
BH	2589	2592 = 288 x 9	$\frac{2589}{288} = 8.99$

¹⁷ Another way of looking at the results in Table tbd is that successive PTVs™ expand by the fourth square of twelve (576).

Notice that the top in 1/1948 coincided with TWO PTVs™ coming together at the same point, i.e., the one originating in 2/1920 and the one originating in 12/1932. Both of these PTVs™ were multiples of the square of twelve. When this happens it is a strong indication that a major turning point has been reached.

ENERGY LEVELS FROM THE 1948 TOP

The spacing of points of force in soybeans was such that the second major top in 1948 produced a location in price-time from which quantum energy levels were defined. Chart XIV.B shows these energy levels in a series of arcs originating in 1948 and extending to the bottom in 1986. Notice that the three major turning points in 1920, 1973, and 1975 were all equidistant from the point in 1948, i.e., their PTVs™ were all the tenth square of twelve (or similarly, 5 pairs of 144).

It should now be clearer how energy levels radiate from points of force in the lattice of price-time.

A growth spiral that has occurred more recently will now be studied to further prove that the square of twelve and the sequence of odd integers define the expansion of price-time growth spirals within the soybean market. This spiral began in 1977 and is still unfolding.

GROWTH SPIRAL FROM 1977 TO THE PRESENT

Lesson XIII of *Square Of Twelve* showed that partitioning of the square of twelve often resulted when the direction of PTVs™ were changed by strong areas of support or resistance. This partitioning was proven when it was shown that the SUM of two successive PTVs™ consistently equalled a multiple of the square of twelve, even though the individual PTVs™ were not integrally divisible by 144.

THE COMBINED BULL AND BEAR PHASES OF A CYCLE REPRESENT THE INDIVIDUAL CELLS OF A GROWTH SPIRAL. THE MAGNITUDE OF THE COMPLETE CELL IS DETERMINED WHEN THESE TWO PARTS ARE SUMMED.

The PTV™ is the unique tool that allows a very precise measurement of these growth spiral cells within the element of price-time.

Partitioning of the square of twelve did not occur with the specific PTVs™ studied in the 1913-1969 growth spiral because the energy level during this time was low enough that a weekly time component represented the balancing of price and time. When a market is at a low energy level, sufficient time expires between points of force

CHART XIV.B

QUANTUM ENERGY LEVELS FROM 1948

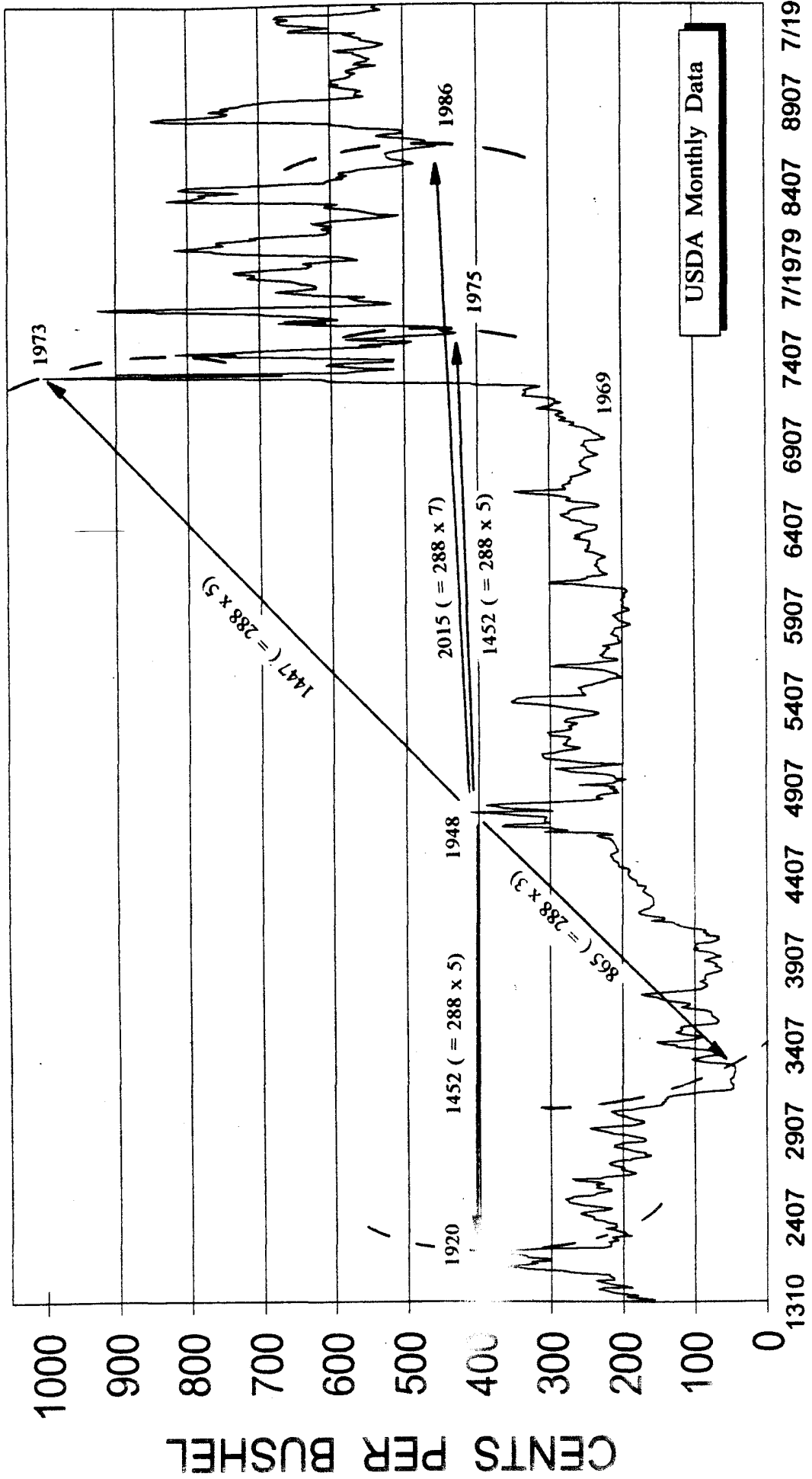

Monthly

to allow turning points to occur at integral multiples of the square of twelve, making partitioning unnecessary. However, after 1969, the price movements were much more vertical and the PTVs™ encountered the upper and lower containment perimeters of the spiral at locations in their growth that were not integral multiples of 144. This concept was explained in Lesson XII, Figure 12.4.

It is the higher energy level during this time that requires a daily time component for PTVs™.¹⁸

It will now be proven that not only are the sums of these PTVs™ equal to integral multiples of the square of twelve, but also that the value of each sum follows the sequence of odd integers as the growth spiral unwinds.

Chart XIV.C shows the growth spiral that has been unfolding in the cash soybean market since 1977. The data for this chart are contained within Table 14.4.

Table 14.5 identifies the paired PTVs™ from Chart XIV.C. A few of these sums were provided in Lesson XII of *Square Of Twelve* when vectorial partitioning was studied. Column two of this table contains the sum of successive pairs of PTVs™ and the corresponding multiple of the square of twelve is shown in column three. Column four contains the results of dividing the sum of the PTVs™ shown in column two by the square of twelve. Notice how precisely these quotients are defined by the same sequence of odd integers identified in the 1913-1969 growth spiral, i.e.,

3, 5, 7, 9, etc.

One implication of the results shown in Table 14.5 is the almost unbelievable simplicity of the techniques used to define the price-time growth spiral. With all the inherent complexities of a modern financial market it is remarkable that the daily price-time structure for a period exceeding fifteen years was reduced to such a simple principle, which can be summarized as follows:

THE SUM OF SUCCESSIVE PTVs™ WITHIN THE GROWTH SPIRAL ARE DEFINED BY TWO FACTORS:

- (1) THE SQUARE OF TWELVE**
- (2) THE SEQUENCE OF ODD INTEGERS**

¹⁸ Refer to page 6, question 2, in *Square Of Twelve*, for a description of the methodology used in determining the correct time units to use for PTV™ calculation.

Table 14.4
PTV™ Calculations for Chart XIV.C Using Daily Data (1977 - 1994)
(These Prices Were Recorded at Decatur, Illinois)

Price-Time Radius Vector™	Date of Low	PTV™ Price Low	Date of High	PTV™ Price High	Time Change in Trading Days	Price Change in Cents	Vector Value (PTV™)
JK	2/9/1978	543.5	11/18/1977	610.0	55 Days	66.5	86.3
LZ	10/20/1977	482.5	5/25/1978	734.5	149 Days	252	292.8
ZM	8/8/1978	604.25	5/25/1978	734.5	51 Days	130.25	139.9
MN	8/8/1978	604.25	6/22/1979	853	219 Days	248.75	331.4
NX	3/3/1980	567	6/22/1979	853	193 Days	286	345.0
XP	3/3/1980	567	11/21/1980	905	162 Days	338	374.8
PQ	10/4/1982	483.5	11/21/1980	905	464 Days	421.5	626.9
QR	10/4/1982	483.5	9/21/1983	925.5	242 Days	442	503.9
QY	10/4/1982	483.5	5/21/1984	881	408 Days	397.5	569.6
RS	10/7/1986	454	9/21/1983	925.5	757 Days	471.5	891.8
ST	10/7/1986	454	6/21/1988	1004	423 Days	550	693.9
TU	10/13/1989	528.5	6/21/1988	1004	330 Days	475.5	578.8
TV	10/2/1992	511.5	6/21/1988	1004	1073 Days	492.5	1180.6
TR	9/21/1983	925.5	6/21/1988	1004	1180 Days	78.75	1182.6
UW	10/13/1989	528.5	6/17/1994	700.5	1170 Days	172	1182.6
TX	10/7/1994	500.0	6/21/1988	1004	1579 Days	504	1657.5

Therefore, the vectorial expansion within the growth spiral, as it unfolded from its beginning point in 1977, was very precisely defined by the two simple principles listed above. These results worked out for the entire span of the growth spiral with an accuracy well within the resolution of the available data.

Page 44 of *Square Of Twelve* noted that as more successive PTVs™ are added together their sum more closely approaches a perfect square of twelve. This fact allows the analyst to precisely pinpoint PTV™ values as more PTVs™ have been recorded. For example, the sum of ST and TV varied from the thirteenth square of twelve by 2.5 units (1874.5 - 1872 = 2.5). However, when the PTVs™ that represent

CHART XIV.C

QUANTUM ENERGY LEVELS (1977 - 1992)

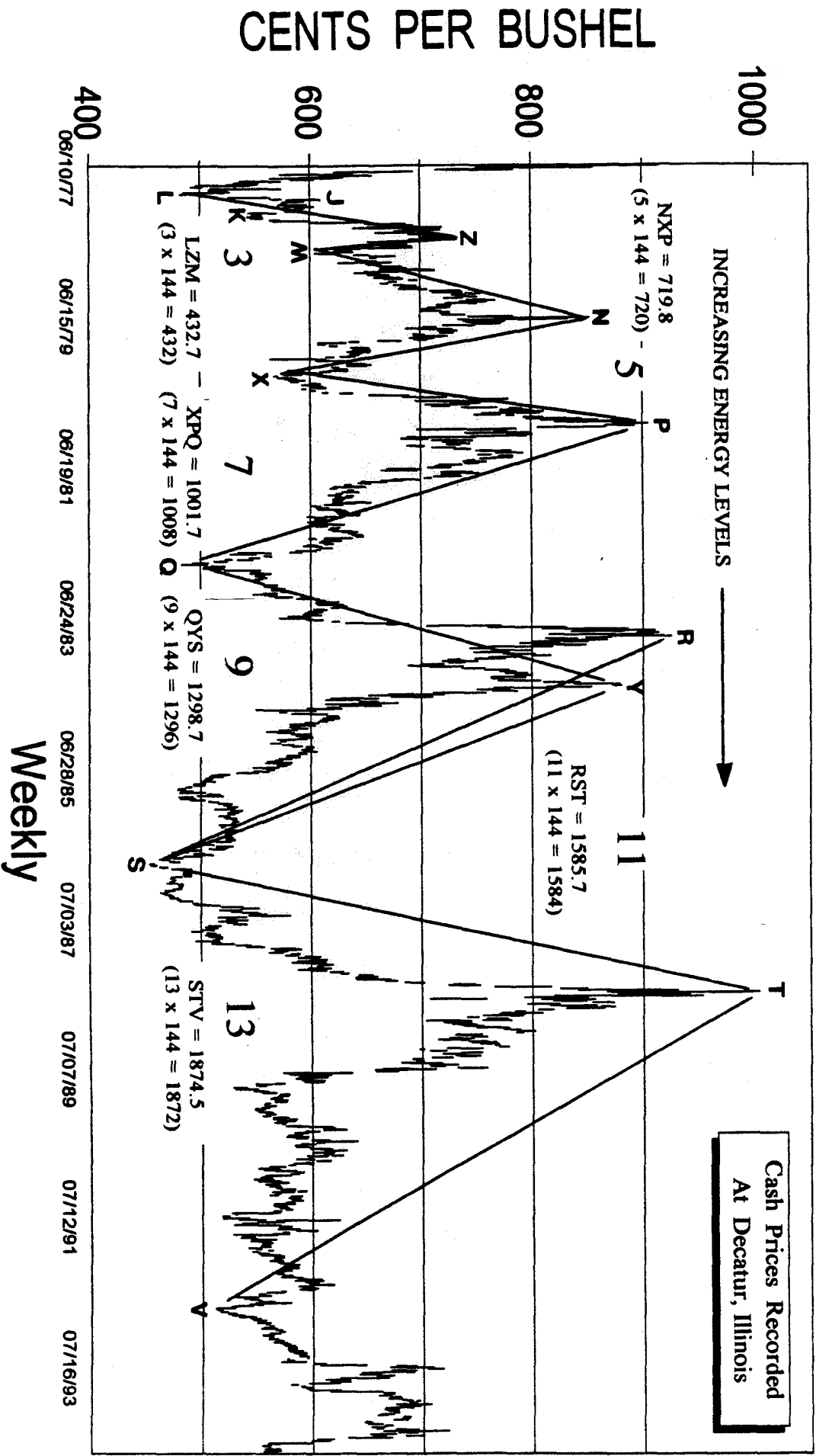

5, 7, 9, 11, and 13 are added together, their sum is 6480.4, which differs from the forty-fifth square of twelve by only 0.4. That is,

$$\left. \begin{array}{l} 5 + 7 + 9 + 11 + 13 = 45 \\ \text{And, } 45 \times 144 = 6480.0 \end{array} \right\}$$

The sum of the corresponding PTVs™ are:

$$\begin{array}{cccccc} & 5 & & 7 & & 9 & & 11 & & 13 \\ (NX + XP) + (XP + PQ) + (QY + YS) + (RS + ST) + (ST + TV) = \\ 719.8 + 1001.7 + 1298.7 + 1585.7 + 1874.5 = 6480.4 \end{array}$$

This means that when point L arrived, its value would have been projected to within 0.4 units, using a daily time component.

Table 14.5
Relation Of Paired PTVs™ (1977 - 1992) To The Sequence Of Odd Integers
(Data Used For These PTVs™ Were Recorded at Decatur, Illinois)

Pair Of PTVs™	Sum Of PTVs™ From Column One	Corresponding Multiple Of 144	Sum Of PTVs™ (From Column Two) Divided By 144
LZ + ZM	292.8 + 139.9 = 432.7	3 x 144 = 432	$\frac{432.7}{144} = 3.01$ (3)
NX + XP	345.0 + 374.8 = 719.8	5 x 144 = 720	$\frac{719.8}{144} = 5.00$ (5)
XP + PQ	374.8 + 626.9 = 1001.7	7 x 144 = 1008	$\frac{1001.7}{144} = 6.96$ (7)
QY + YS	569.6 + 729.1 = 1298.7	9 x 144 = 1296	$\frac{1298.7}{144} = 9.02$ (9)
RS + ST	891.8 + 693.9 = 1585.7	11 x 144 = 1584	$\frac{1585.7}{144} = 11.01$ (11)
ST + TV	693.9 + 1180.6 = 1874.5	13 x 144 = 1872	$\frac{1874.5}{144} = 13.02$ (13)

During the eighteen years that this growth spiral has been unwinding, nearly every possible condition has existed that traditional market analysts use to try to explain price changes. There have been floods, droughts, both good and bad crops in South America, varying production costs, currency fluctuations, etc. However, when the product was finally sold in Decatur the two simple principles listed above defined the exact prices paid for this commodity, proving that all an analyst needs to be aware of are a few basic natural laws. Once these laws are understood, weather conditions, news events, and other "causes" will be seen to be governed by them as well.

DETERMINING ONE ELEMENT OF THE SUM GIVES BOTH ELEMENTS

The size of the cells within the growth spiral studied in the last section were measured by summing the two successive PTVs™ that defined the spatial displacement between their high and low extremes in price-time. Now that the order defining these cells has been proven beyond a reasonable doubt, the next step in this analysis is to see how one component of the sum can be determined.¹⁹ The significance of this can not be overstated because once one item of the sum is known, the other item is also known because the total sum follows the rules outlined above. After a PTV™ that defines the extent of a rally or one that defines a decline is determined, this value is subtracted from the projected sum to determine the second element in the sum.

Many techniques can be used to determine one item of the sum. The reader is encouraged to research some of these on his own. Among those that the author has proven to work are:

- (1) Determine the number series progression that describes the amount of partitioning of PTVs™ within each cell. There is a simple relation between the partitioning of successive pairs of PTVs™ within the growth spiral.
- (2) Determine the relation between successive rallies.
- (3) Determine the relation between successive declines.

The Fibonacci ratio, 1.618, will be used in the next section to demonstrate the relation between each of the declines within this growth spiral. When this knowledge is coupled with the information provided in the preceding sections of this lesson the extent of both the price-time rallies and declines are known.

¹⁹ The "one component of the sum" referred to here is either the PTV™ defining the rally or the PTV™ defining the decline.

FIBONACCI RATIOS IN CURRENT GROWTH SPIRAL

To determine the **EXACT** magnitude of **BOTH** the advancing and declining PTVs™ within a growth spiral cell it is simply a matter of determining either of these elements. After one value is known, its mated PTV™ is calculated by subtracting from the appropriate multiple of 144 the value of the determined PTV™. These techniques identify the location of points of force across the entire span of the growth spiral, which can be decades or even centuries in advance.

The fact that the Fibonacci ratio, 1.618, has not received much attention in this series of books is not because it is inapplicable to this method of analysis. As stated in *Four-Dimensional Stock Market Structures And Cycles*, the analyst needs to know when and where to apply this tool. Unfortunately, contemporary market analysts multiply everything under the sun by 1.618 and try to use this as a forecasting tool.

Fibonacci can now be used in this analysis because the necessary background knowledge has been presented in the preceding thirteen lessons.²⁰ This ratio will be used to show the underlying order that relates each of the declines in this growth spiral so that its entire form can then be laid out. The progression defining the expansion of these declines can be modeled using only three factors:

- (1) The first major recorded decline within this growth spiral
- (2) The Fibonacci ratio (PHI = 1.618)
- (3) Ratios of simple integers

Chart XIV.D shows all the major declines that have occurred since the growth spiral began in 1977. The price and time scales of each graph has been adjusted so that they all fit across the entire width of the chart. Notice how similar the form of each of these movements are. This is an example of the fractal nature of growth spirals.

The first major decline within this growth spiral, JK, is shown at the top of Chart XIV.D. Table 14.4 showed that its vectorial magnitude was 86.3, which is the musical sixth of the square of twelve. Since the musical sixth is the ratio of three to five, the value of JK is:

$$\text{Value of first major decline} = 144 \times 3/5 = 86.3$$

²⁰ Fibonacci is an optional approach to this problem. Those working on this material can prove to themselves that it is unnecessary in order to establish the relationships between movements within growth spirals.

CHART XIV.D

COMPARISON OF DECLINES

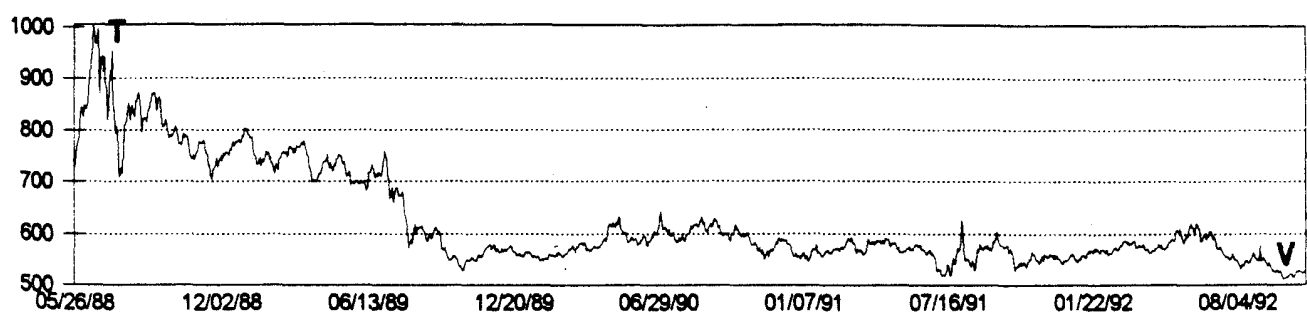
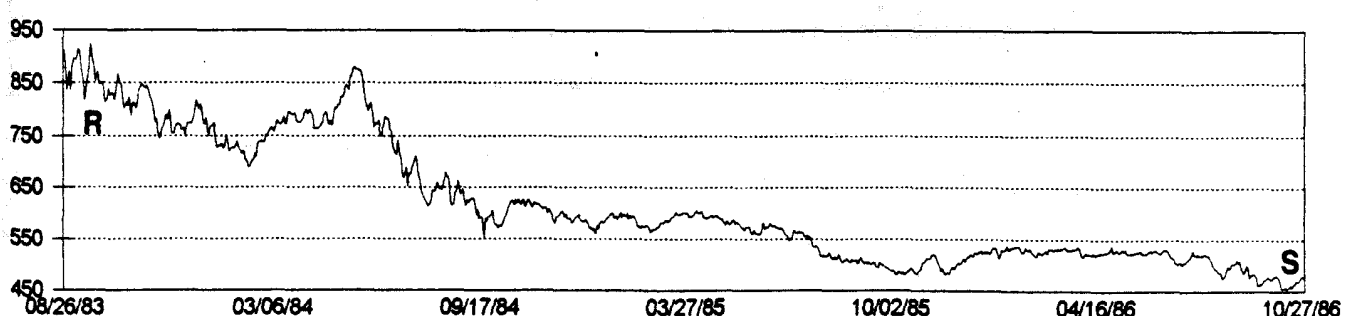
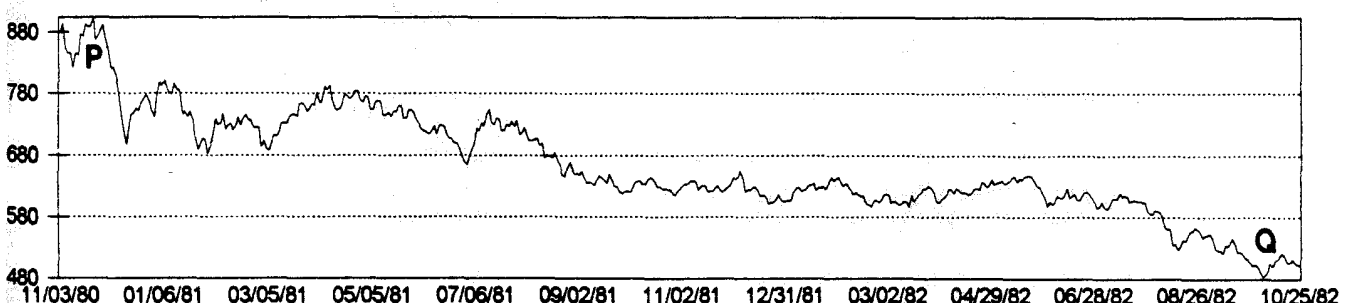
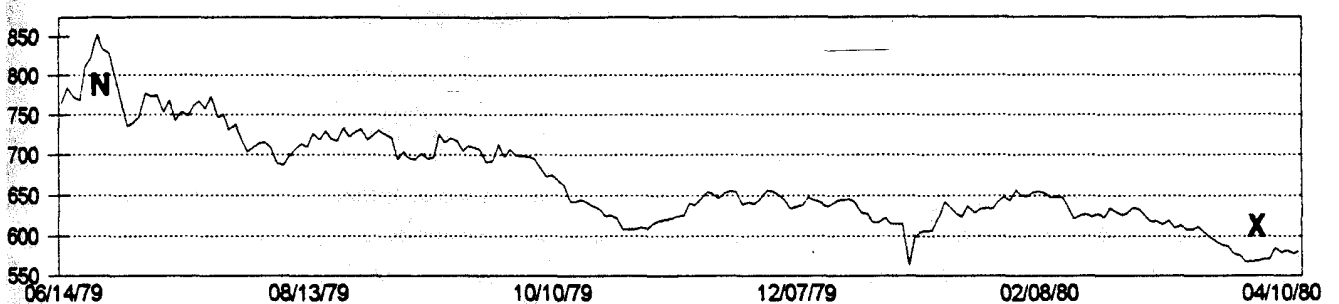
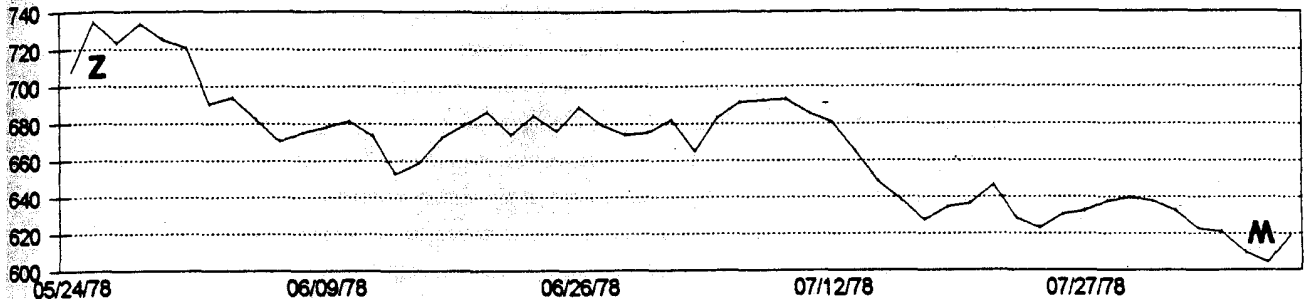
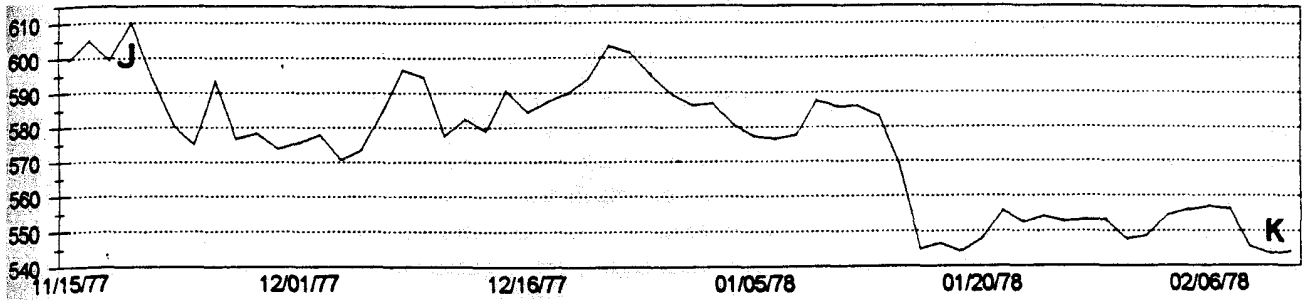

This relation of 86.3 to the square of twelve must be remembered because it shows that all rallies and declines in this growth spiral were closely associated with 144.

The Fibonacci relation between JK and subsequent declines are summarized in Table 14.6. The first decline of this spiral was used for these comparisons because the general methodology is to establish as many common elements as possible with each constituent decline, then factor these common elements out of the equation. When as many common elements as possible are removed from consideration it allows the underlying numerical expansion to be modeled.

Notice how closely each of the declines in Table 14.6 were defined by simple relations of JK to PHI. It must be remembered that the exact value of JK was difficult to determine because the available data does not provide for the number of "significant digits" shown in this table. However, as other declines unfolded, the relation of JK to subsequent movements was more clearly defined. For example, when RS completed and was measured to be 891.8 the value of TX was known to be:

$$TX = RS \times (3 / \phi) = 891.8 \times (3 / \phi) = 1653.5$$

Determining the numerical relations that connect all the values in Table 14.6 is left as an exercise for the reader because those genuinely interested in finding the underlying order of financial markets should be expected to do at least some of the work involved. Once the relation between these declines is known, the rallies are also known because their sum has been proven to be an integral multiple of 144.

Table 14.6
Fibonacci Relations Within The Current Growth Spiral
Between The First Major Decline And Subsequent Declines
(See Chart XIV.D)

PTV TM Measuring Successive Declines	Relation Of PTV TM To The First Decline In The Growth Spiral (JK = 86.3)
JK = 86.3	N/A
ZM = 139.9	$86.3 \times \phi = 139.6$
NX = 345.0	$86.3 \times 4 = 345.2$
PQ = 626.9	$86.3 \times 4.5 \times \phi = 628.3$
RS = 891.8	$86.3 \times 1.5 \times \phi^4 = 887.2$
TV = 1180.6	$86.3 \times 2 \times \phi^4 = 1182.9$
TX = 1657.5	$86.3 \times 4.5 \times \phi^3 = 1645.0^{21}$

²¹ Also, note that: $144 \times 11.5 = 1656$. This shows how all these values come back to the square of twelve.

Two of the very important concepts that have been applied thus far in the analysis of this growth spiral are:

- (1) **THE FORM OF THE UPPER AND LOWER CONTAINMENT PERIMETERS OF THIS SPIRAL CAN BE MODELED WITH APPLICATIONS OF THE FIBONACCI RATIO.**
- (2) **THE PTVS™ WITHIN THIS SPIRAL PARTITION SO THAT THE SUM OF TWO SUCCESSIVE VECTORS EQUALLED A SQUARE OF TWELVE.**

Fibonacci is one of the relationships that describes the "nautilus" form assumed by the support and resistance perimeters of the growth spiral. Within these two containment fields, the square of twelve defines the sum of two successive vectorial movements.

Knowledge of the nautilus form of the growth spiral provides another tool to use in determining the extent of expected partitioning at each point where the PTVs™ touch the perimeter of the spiral. If the reader will take each decline listed in Table 14.6 and subtract the largest integral amount of the square of twelve²² he will find relations between the remainders. Armed with this knowledge the analyst is able to precisely predict the magnitude of each PTV™ within this growth spiral.

Another clue to the underlying order within the growth spiral are the relations between AB and the rallies. Table 14.7 shows each of these for the major rallies shown on Chart XIV.C. Although it is not necessary to use AB as the unit of comparison in order to see the relations between the rallies, it was included here for consistency with the techniques that were used in comparing each of the declines.

Most of the PTVs™ in Tables 14.6 and 14.7 were studied in Lesson XII, *Vectorial Partitioning*, where it was shown which pairs of these vectors form nearly perfect squares of twelve. And since the relations in Tables 14.6 and 14.7 also incorporate the square of twelve, it provides a simple system to algebraically model these movements.

Soybean market analysis is facilitated by the fact that the major tops and bottoms are very sharp, providing very clearly defined turning points. Flat tops can spread out over a period of years making it very difficult to pinpoint the exact

²² Mathematicians know this as "mod 144", which simply means subtract out as many values of 144 as possible and find what the remainder is.

WWW.FOREX-WAREZ.COM
ANDREYBBRY@GMAIL.COM SKYPE: ANDREYBBRY

terminus of the PTV™. For example, try to find the date of the DJIA high at the 1976 top.

Table 14.7
Fibonacci Relations Within The Current Growth Spiral
Between The First Major Decline And Subsequent Rallies
(See Chart XIV.C)

PTV™ Measuring Successive Rallies	Relation Of PTV™ To The First Decline In Growth Spiral (JK = 86.3)	Equations In Column Two With 144 Substituted For 86.3 x (5/3)
MN = 331.4	$86.3 \times (3/2) \times \phi^2 = 338.9^{23}$	$144 \times (8 \times 3/5 - 5/2) = 331.2$
XP = 374.8	$86.3 \times (5/3) \times \phi^2 = 376.6$	$144 \times \phi^2 = 377$
QR = 503.9	$86.3 \times (5/3) \times (7/2) = 503.4$	$144 \times (7/2) = 504$ ———
ST = 693.9	$86.3 \times 8 = 690.4$	$144 \times 8 \times (3/5) = 691.2$

When knowledge of the growth spiral is coupled with planetary cycle work it makes a powerful timing combination. Planetary cycles will be studied in the next lesson.

EXAMPLE OF PTV™ PROJECTION

The following example of how to project a future value for a PTV™ is included as an academic exercise only. The objective is to demonstrate for the analyst one of many possible methods that can be used to make such a projection, and how available options can be identified, while those less likely to occur are eliminated. This analysis will be limited to applications of the material that has already been presented in this and preceding lessons.

Of the three possible conditions listed below, the author will not indicate which he feels is the most likely to transpire, this work is left for the reader. However, enough material has been presented that the analyst should be able to make a rational decision on his own.

²³ A closer relationship is: $86.3 \times [8 - (5/3) \times (5/2)] = 330.8$

Chart XIV.C showed that the thirteenth square of twelve completed at the bottom in 10/1992. Based on this information, there are three possibilities facing the analyst at this time:

- (1) Has the growth spiral that began in 1977 completed?
- (2) If this growth spiral did not complete in 10/1992,
 - (a) Is the movement currently underway, from the bottom in 10/1992, the first part of a partitioned PTVTM?
 - (b) Is the movement currently underway, from the bottom in 10/1992, the second part of a partitioned PTVTM, where the first part was defined by TV?

One of many ways to determine if the growth spiral has completed is to see if its total expected duration has expired. In other words, this spiral has been unfolding for eighteen years, is that the time interval expected for this spiral?

Other ways to determine if this spiral has expired include using planetary cycle analysis or ellipses.

If this spiral is still in force, the problem reduces to the two options listed above in item (2), i.e., determining whether or not TV was the first component of the partitioned PTVTM that will be the fifteenth item in the series.²⁴ If TV was not the first component of this sum then the PTVTM off the 1992 low is the first component and the second will be defined when the top is reached and the trend reverses into the next low. If this is the case, the magnitude of the second PTVTM will be very precisely determined years in advance when the top is reached, completing the first element of the sum. The second element of the sum is always the easiest to project.

Since the partitioned PTVsTM within this growth spiral follow the sequence of odd integers, and the last completed element in this series was thirteen, the next combination of PTVsTM in this series is fifteen. When multiplied by the square of twelve this value is 2160, i.e.,

The next element of the number series = $15 \times 144 = 2160$.

REMEMBER THAT 2160 IS THE SUM OF TWO PARTITIONED PTVSTM.

²⁴ Since the last completed item in the series was thirteen, the next item is fifteen.

At the current point in time (June, 1995), the easiest of the three possibilities is if the growth spiral is still in force and if TV was the first component of the sum, because this clearly defines the next expected PTV™ value. This value is determined by subtracting the magnitude of TV, 1180.6, from the sum of 2160, producing a value for the projected PTV™ of:

$$\text{Possible magnitude of next PTV}^{\text{TM}} \text{ in spiral} = 2160 - 1180.6 = 979.4$$

This possible projected PTV™ value can be rechecked by seeing if it fits into the numeric progression of the preceding advances shown in Table 14.7.²⁵

To know if the first half of this partitioned PTV™ was defined by TV it is helpful to know if TV moved along a common face between two cells, such as FG between the five and seven cells, and IJ between the nine and eleven cells. In order for the projected PTV™ to equal 979.4, TV must be the common face between the thirteen and fifteen cells because it has already been shown to be the second part of the 13 cell.

If TV was not part of the 15 cell, then the projected PTV™ would not necessarily equal 979.4.

As of the date of this writing (June, 1995) there have been approximately 670 trading days that have expired since the 10/1992 bottom. And since prices are hovering near 570, which is on the one-eighth retracement line identified in Appendix D in *Square Of Twelve*, the current magnitude of the PTV™ from the 1992 low is approximately 674. This does not leave much room until the 979.4 PTV™ is reached, implying that either a quick dramatic rally is due or the action is currently in the first component of the fifteen cell and not the second.

To demonstrate how quickly prices would have to change from the current levels, the 1x2 diagonal angle will be used to calculate this point in price-time. The 1x2 is used because the action followed this angle from the 10/1992 bottom until the top in 5/1994 (the market ran up 212 points in 409 trading days).

The angle between the hypotenuse and the adjacent side of a triangle following the 1x2 diagonal angle is given by the \tan^{-1} of 0.5, which is 26.57° . Therefore, the two sides of the triangle are given by the sin and cos of 26.57 multiplied by the expected value for the PTV™.

²⁵ It must be noted that 979.4 is the second square of twelve larger than the rally immediately preceding it, JK, which equalled 693.8. That is, $979.4 - 288 = 691.4$.

That is,

$$\begin{aligned} \text{Time side of the triangle} &= \cos(26.57) \times 979.4 = 0.894 \times 979.4 = 876 \text{ days} \\ \text{Price side of triangle} &= \sin(26.57) \times 979.4 = 0.447 \times 979.4 = 438.0 \text{ cents} \end{aligned}$$

Therefore, in order for the action to follow the 1x2 and for the PTVTM length to equal 979.4, prices would have to advance 438 cents in 876 days from the 10/1992 low. This gives a value of 949.5 cents in April, 1996, which would be a very optimistic scenario to say the least.²⁶

If the analyst is unable to determine how to solve this problem, at least he can carry the 979.4 PTVTM along on his charts and be aware for a possible turning point when the price-time action reaches this arc. Remember, this point would be a major top.

The next section will study one of many possible techniques available to determine one of the PTVsTM in the "sum of PTVsTM" described in this section. Determining one of these elements effectively gives them both because their sum is already known. Once this is determined, the extent of both the price-time rallies and declines is known.

Remember, the example given above was presented with the intention of showing one possible technique, using PTVsTM, to make a price-time projection. After mastering vectorial analysis, there are literally hundreds of ways to pinpoint these dates and prices.

CONCLUSION

This lesson began by focusing the reader's attention on a very specific natural law that is directly applicable to financial market timing by reviewing the science of quantum theory and the structure of the atom. With this knowledge, the foundation was laid to present the rules governing vectorial expansion in the soybean market,

²⁶ There have been many assumptions made in this calculation, including that TV was the first component of the fifteenth cell, making the current PTVTM equal to 979.4. Also, that the action will follow the 1x2, as it did between 10/1992 and 5/1994. The trader needs to know that this example was used only as an academic exercise and to illustrate how projections could be made when certain facts are given. As more knowledge is gained, these "givens" will be determinable.

which progresses by the same sequence of odd integers.²⁷ This number series is the same sequence found in quantum theory where, as the periodic table of the elements is progressively filled, the pairs of electrons within filled orbitals of the atom follow the sequence of odd integers.

Quantum theory states that the stability of the orbital within each principal quantum level diminishes in the order s - p - d - f. That is, the "s" orbital is more stable than the "p" orbital and, consequently, fills before an electron moves into the "p" orbital. Similarly, the "d" orbital is more stable than the "f".

The number series of paired electrons was shown in Table 14.1 to be:

1, 3, 5, 7, . . .

This lesson showed that this same sequence of odd integers defined the price-time expansion within the two major growth spirals that have unfolded in the soybean market, since the beginning of data collection in the United States. The two spirals that were studied in this lesson were from 1913 to 1969, and from 1977 to the present.

Because the energy level during the earlier spiral was relatively low, the balancing of price and time occurred with the natural time division of weeks. After completion of the 1913 - 1969 spiral, the action moved into a higher energy level so that a daily time component was used for PTVTM calculation, i.e., price and time balanced along a daily time interval.

Because the vectorial expansion was measured as the sum of two PTVsTM, the Fibonacci relationship was used to analyze the relation between each of the rallies and between each of the declines. Fibonacci, or the golden spiral, describes the expansion between the upper and lower perimeters of the growth spiral. Therefore, when one item of the sum is determined using Fibonacci, the second element is also known because it is simply subtracted from the appropriate multiple of 144.

The current status of the soybean market was studied with three possible future scenarios explained. Regardless of which possibility the analyst chooses, he can carry the projected PTVTM across his charts and be aware when the action arrives at this curve. At this time he should either be out of the market altogether and wait for the action to move beyond the arc, or bring his stop-loss orders up very tightly and on a daily basis.

²⁷ If the reader will take the time to study the gnomonic expansion within these growth spirals he will see that the square of twelve also precisely defines those values. A gnomon is a shape or pattern added to another to enlarge the original without losing the general shape of the original.

In the case of the soybean market, the price-time gnomon is the square of twelve, and it defines the expansion in growth spirals from the monad.

The author has read most of the books worth studying on market timing and analysis and knows many other analysts who devote a good portion of their lives to collecting such material.

NO PUBLICATION TO DATE, BY ANY OTHER AUTHOR, HAS DOCUMENTED THE ORDER WITHIN FINANCIAL MARKET MOVEMENTS WITH THE MATHEMATICAL PRECISION DESCRIBED IN THIS LESSON.

Remember, the PTVs™ used in the analysis of the 1977 growth spiral were calculated using a **DAILY** time component, yet the methodology was consistent across a time interval of over seventeen years. In other words, the accuracy of this analysis is limited by the significant digits inherent in the method of data collection and not with the techniques used.

Market analysts using timing tools such as Fibonacci retracements, Elliott Waves, and dynamic cycles are amazed when their projections work out only occasionally. What this indicates is that they only have a piece of the puzzle. The above description defined a unique market model and proved its validity by demonstrating it in two separate growth spirals, the first lasted 49 years from 1920 to 1969 and the second from 1977 to the present. No models or analysis tools come even close to achieving what has been described in this lesson.

There are many more relationships within these growth spirals that were not included in this work. This is left as a future exercise for those readers serious enough to put in the time and effort to discover them. Those who do make the effort will find their time well rewarded.

It is hoped that the reader will seriously think about the implications of the natural order that has been documented in the lesson. When predictable structure and form can be measured and proven in a financial market it verifies that as masses of men pool their emotions together the result is not a chaotic randomness. Those wild emotional swings that masses of men experience occur at price tops and bottoms when there is an abrupt shift in their dominant state of mind. These changes in feeling do not occur in a constant linear fashion as prices swing from bottoms to tops or from tops to bottoms. Rather, the emotions build exponentially in intensity with the strongest feeling experienced at the top or bottom where prices typically change along a parabolic curve, spiking at the point where they are about to reverse direction. Financial markets are the unique laboratory where these wild emotional swings have been precisely recorded for centuries.

The duration and intensity of each of these mood swings are determined by the extent of the price changes and the time required for the movements. The magnitude

and duration of the prevailing mood is precisely determined by the characteristics of the mood swings that have preceded it. That is what defines the growth spiral nature of financial market price-time charts.

Being able to measure and predict these emotional swings over periods of decades is remarkable enough, but when these changes are described by something as seemingly simple as the square of twelve, it is truly amazing. And adding to the wonder is the recognition in the structure of the atom of the same mathematical model used to measure this order in mass human psychology, providing additional evidence that natural law is universal.

LESSON XV

PLANETARY CYCLES IN SOYBEANS

He who wishes to see how much nature and the heavens can do among us should come to gaze upon her.

... Francesco Petrarch, Italian Poet (1304)

INTRODUCTION

Any thorough cycle analysis of financial markets must begin with the long-term cycles because they define the yearly trend. Only after the locations of these cycles are clearly known should the study shift to the intermediate-term cycles, which last for months or weeks. The major explosive moves that happen once every few decades are caused by the long-term cycles that enter the parabolic part of their curve when they are near completion. It will do traders little good to know the intermediate and short-term trends during explosive moves, such as happened in the soybean market in 1917, 1947 and 1973. During these years, the market experienced vertical movements with one gap following another for periods of several months at a time. Fortunes are made and lost during these dramatic price changes because prices spike up then just as quickly collapse when the top is hit. Traders that watched their positions increase many times their original value often watch them decline back to nothing if they wait too long to get out of the market. This lesson will show that one such major cycle is due to arrive very soon.

The intermediate and short-term cycles are irrelevant during powerful movements such as these.

This lesson will focus on long-term trends in the soybean market and their correlation with the major planetary cycles, beginning with the synodic cycle of Uranus and progressing through each of the cycles of the major planets. The smaller cycles can be identified by the reader by applying the same techniques shown in *Four-Dimensional Stock Market Structures And Cycles*.

As described in the preface of this book, only the general techniques and locations of the major cycles are provided in this lesson. This is necessary because if too much detail is provided publishers will do as they have in the past and lift the author's work directly out of these books and publish it as their "original" market timing tools.

Not only is it dangerous to follow techniques that have not yet been mastered, but it also detracts from the credibility of the techniques when they are not applied correctly.

Four-Dimensional Stock Market Structures And Cycles showed the correlation between stock market cycles and the synodic and sidereal motions of the planets. That work systematically studied the complete cycles of the planets beginning with the eighty-four year Uranus sidereal cycle and ending with the eighty-eight day Mercury cycle.

URANUS

Uranus was officially discovered in 1781 by William Herschel and for many years was named after him. It was not until the middle of the nineteenth century that the name proposed by Johann Bode, Uranus (the mythological father of Saturn), was universally accepted.

Uranus is the "odd-ball" of the solar system for a variety of reasons. While most of the planets have their axes of rotation close to perpendicular to their plane of orbit, Uranus is rotated 98° from this orientation. That is, Uranus's axis of rotation is nearly parallel to its orbital plane. This is the only planet in the solar system with this odd peculiarity.

Another characteristic of Uranus unique in the solar system is its bluish-green color, caused by the relatively large amount of methane in its atmosphere. Methane absorbs the red spectrum of light, leaving the blue-green for reflection back to the observer. In 1986 Voyager Two verified that the maximum concentration of methane in Uranus's atmosphere occurs at "one atmosphere", which is the physical standard used for the atmospheric pressure at sea level on Earth. Methane was identified in *Four-Dimensional Stock Market Structures And Cycles* as a nearly perfect tetrahedral compound, a symmetry that was verified in the DJIA.

The advanced topics section of this lesson will list other less obvious characteristics of Uranus, as it relates to life on Earth.

URANUS TRINE AND MAJOR SOYBEAN TOPS

The Uranus trine is correlated with one of the most important cycles in the soybean market because it is associated with the major tops and bottoms. This is the cycle where fortunes are made or lost. What makes this cycle of particular interest is that it is due to top relatively soon in the year 2001, meaning that analysts and traders have only a few years to prepare for this once-in-a-lifetime opportunity. Serious market students have enough time to thoroughly research this market to determine for themselves if this is a move they want to trade.

Chart XV.A shows the complete record of the soybean market from October, 1913 to December, 1994. The vertical lines on this chart show the trine (120°) of the Uranus cycle beginning at the multiple top in February, 1918, where the location of Uranus was $23^{\circ}43'$ Aquarius.²⁸ Table 15.1 shows that from the top in 1918, every Uranus trine has been associated with a major top. These tops have been:

- (1) The top in February, 1918 occurred when Uranus was at $23^{\circ}43'$ Aquarius.
- (2) The top in January, 1948 was at $24^{\circ}28'$ Gemini, or $120^{\circ}45'$ from the 1918 top.
- (3) The top in June, 1973 occurred when Uranus was at $21^{\circ}51'$ Libra, or $238^{\circ}08'$ from the 1918 top.
- (4) The next trine is due in the year 2001, which is one complete Uranus cycle from the 1918 top.

The elliptical motion of Uranus explains why there was a thirty-year interval between the 1918 and the 1948 tops, while only 25 years elapsed between the 1948 and 1973 tops. The fastest part of a planet's orbit occurs when it is near the sun, or at perihelion. When it moves away from the sun it slows down until it reaches aphelion. Because Uranus was closer to the sun between the two tops in 1948 and 1973 its speed increased, resulting in less time elapsing as it moved 120 degrees. Between the two tops in 1918 and 1948 Uranus was further away from the sun, resulting in more time elapsing between its 120 degree movements. Even though these tops were unevenly spaced in time, they were separated by 120 degree movements of Uranus.²⁹

Similarly, the 60 degree interval when Uranus was at the slower part of its orbit took fifteen years, while the same 60 degree interval at the fastest part of its orbit was correlated with the 13-year cycle. That is, the advance from 10/1960 to 6/1973 and the subsequent decline from 6/1973 to 10/1986 both lasted 13 years and a nearly perfect 60° movement of Uranus, while the decline from 2/1918 to 12/1932 and the subsequent advance from 12/1932 to 1/1948 both lasted 15 years and 60° of Uranus.

²⁸ As mentioned in previous lessons, market data was only recorded for five month out of the year during this time, making it difficult to know exactly where the actual top occurred.

²⁹ Chart VIII.S showed a similar condition in the Mars cycle. Notice the uneven spacing in time between the trines shown on that chart.

WWW.FOREX-WAREZ.COM
ANDREYBBRV@GMAIL.COM SKYPE: ANDREYBBRV

CHART XV.A

URANUS TRINE AND SOYBEAN TOPS

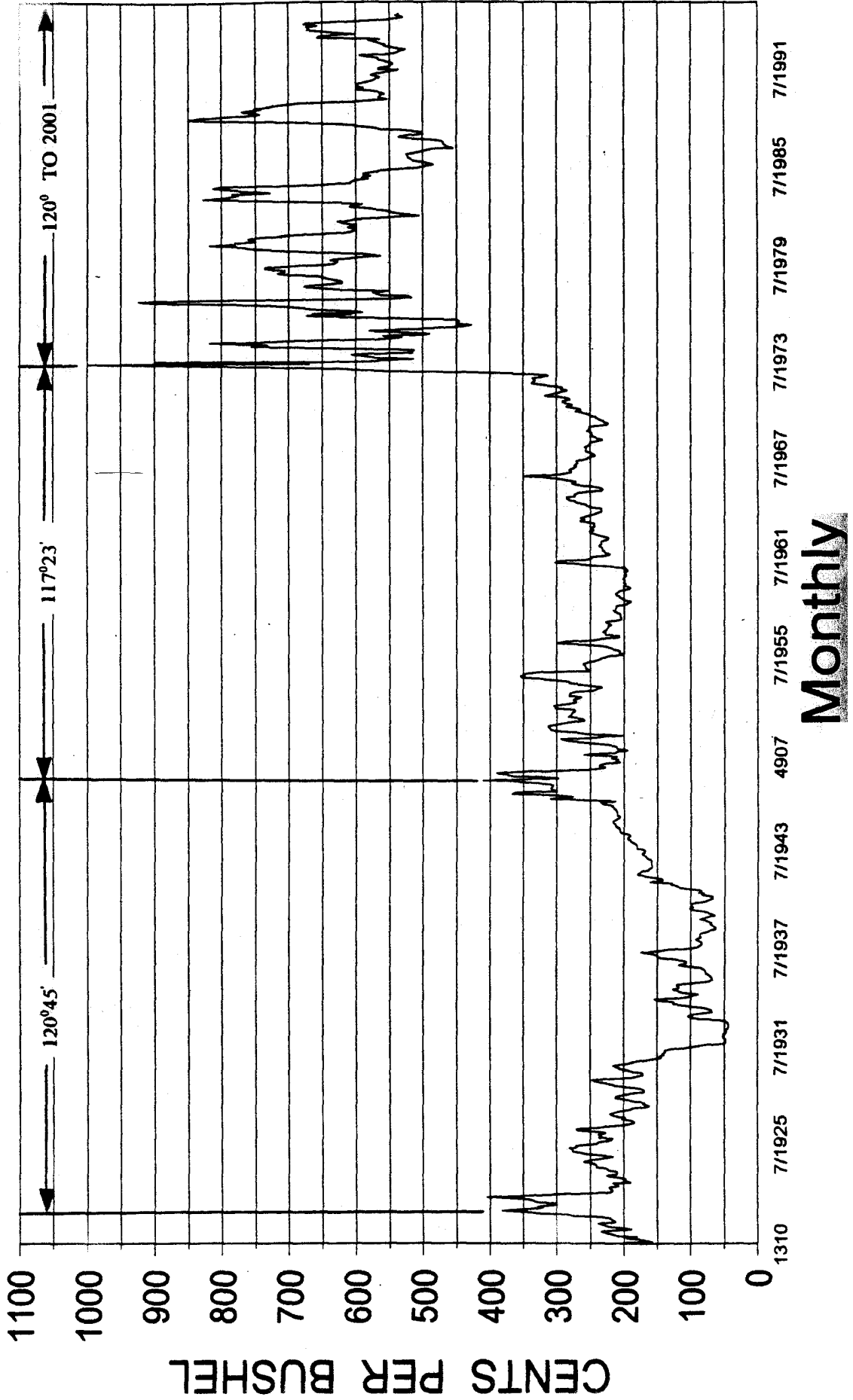

Monthly

Table 15.1
Uranus Trines And Soybean Tops 1918 - 2001
 (See Chart XV.A)

Date Of Top	Location Of Uranus At Top	Change In Position From Last Top
2/1918	23°43' Aquarius	N/A
1/1948	24°28' Gemini	120°45'
6/1973	21°51' Libra	117°23'
2001	21°51' Aquarius	120°

URANUS TRINE AND MAJOR SOYBEAN BOTTOMS

Just as the Uranus trine is associated with major tops in the soybean market, so are its opposite trines associated with major bottoms. Chart XV.B shows these bottoms, which are located 60 degrees from the tops listed in Table 15.1.

Table 15.2 summarizes this cycle since 1932, where the bottoms associated with this trine have been:

- (1) The all-time low in soybeans occurred in December, 1932 at 44 cents per bushel. Uranus at this time was located at 22°03' Aries. This bottom was 58°20' from the top in 1918.
- (2) When Uranus moved 120°09' from the December, 1932 bottom the soybean market again arrived at a major bottom in October, 1960.
- (3) The third trine shown on Chart XV.B occurred in October, 1986 when Uranus arrived at 21°50' Sagittarius. This bottom dropped the price down to the bottom of the trend arc (see Chart XIII.B) with prices reaching 455 cents per bushel. At this time, Uranus was 119°38' from its position at the October, 1960 bottom and 239°47' from the all-time low in December, 1932.³⁰

³⁰ Notice that these trines of Uranus are less than one-half of one degree from the perfect value. This difference is very small because it is only a few days in a cycle that averages 28 years.

CHART XV.B

URANUS TRINE AND SOYBEAN BOTTOMS

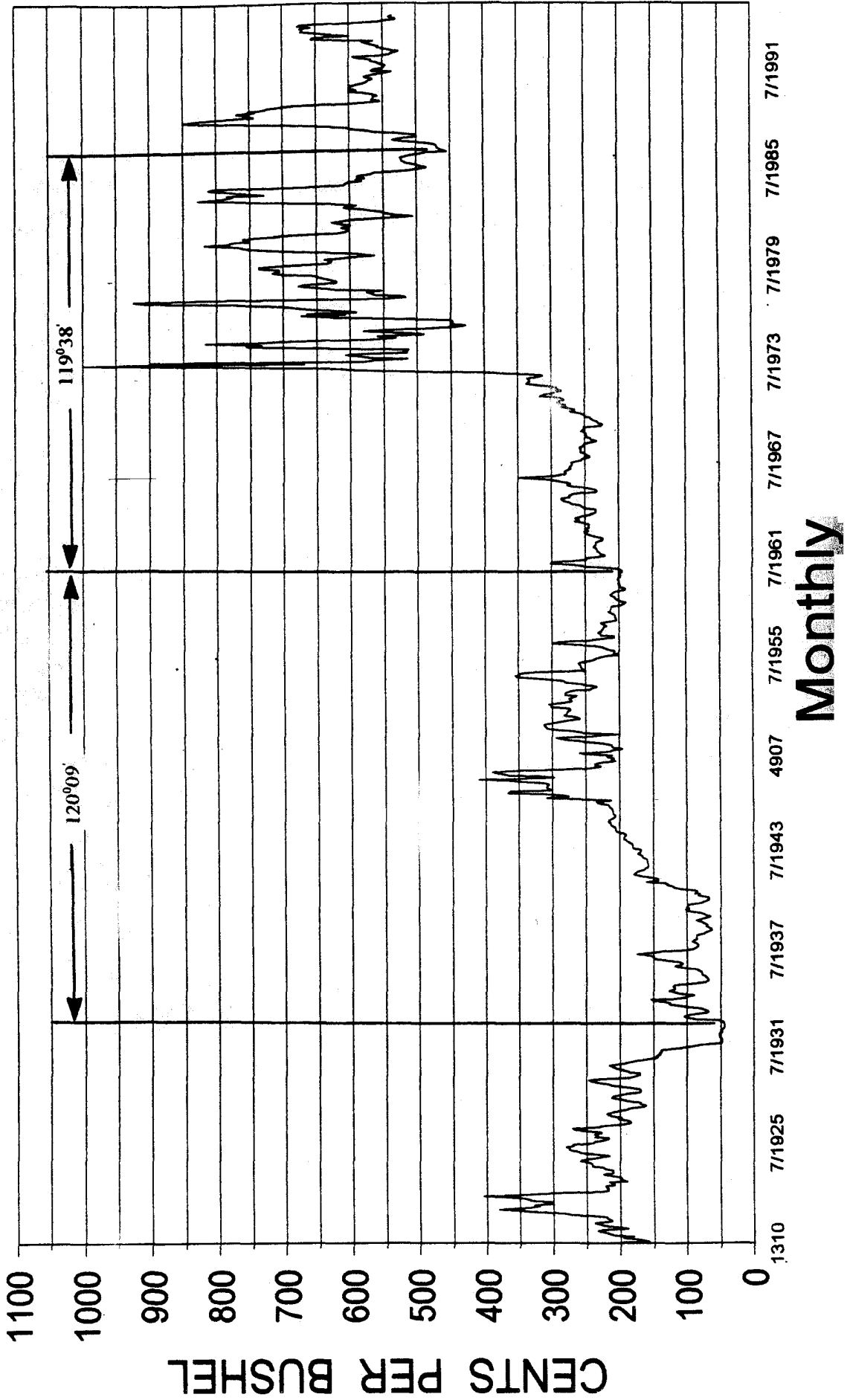

Table 15.2
Uranus Trines And Soybean Bottoms 1932 - 2016
(See Chart XV.B)

Date Of Bottom	Location Of Uranus At Bottom	Change In Position From Last Bottom
12/1932	22°03' Aries	N/A
10/1960	22°12' Leo -	120°09'
10/1986	21°50' Sagittarius	119°38'
2016	22° Aries	120°

When the two trines from Charts XV.A and XV.B are put together there is an alternating trend of advancing and declining prices associated with 60 degree motions of Uranus, as shown on Chart XV.C.

The accuracy and predictability of this cycle is quite remarkable. Even though these trines average 28 years, they coincide with major soybean tops and bottoms within a few days of resolution.

As explained earlier, the elliptical nature of the underlying planetary cycle explains why there was a varying time interval between these turning points. Analysts applying a fixed 26 or 28-year cycle will see this cycle hit once then miss the next time it is due by as much as four years. This can be verified by studying column one in Table 15.2, which shows the intervals between the bottoms to be:

28 years, 26 years, 30 years

The intervals between the three cycle bottoms listed above add up to the complete 84-year Uranus cycle.

Similarly, the spacing between the major tops was:

30 years, 25.5 years, 28 years

As with the bottoms, these tops do not fit into a fixed periodicity of either 26 or 28 years, providing additional proof of their correlation with the elliptical Uranus cycle.

CHART XV.C

URANUS TRINE AND ALTERNATING TRENDS

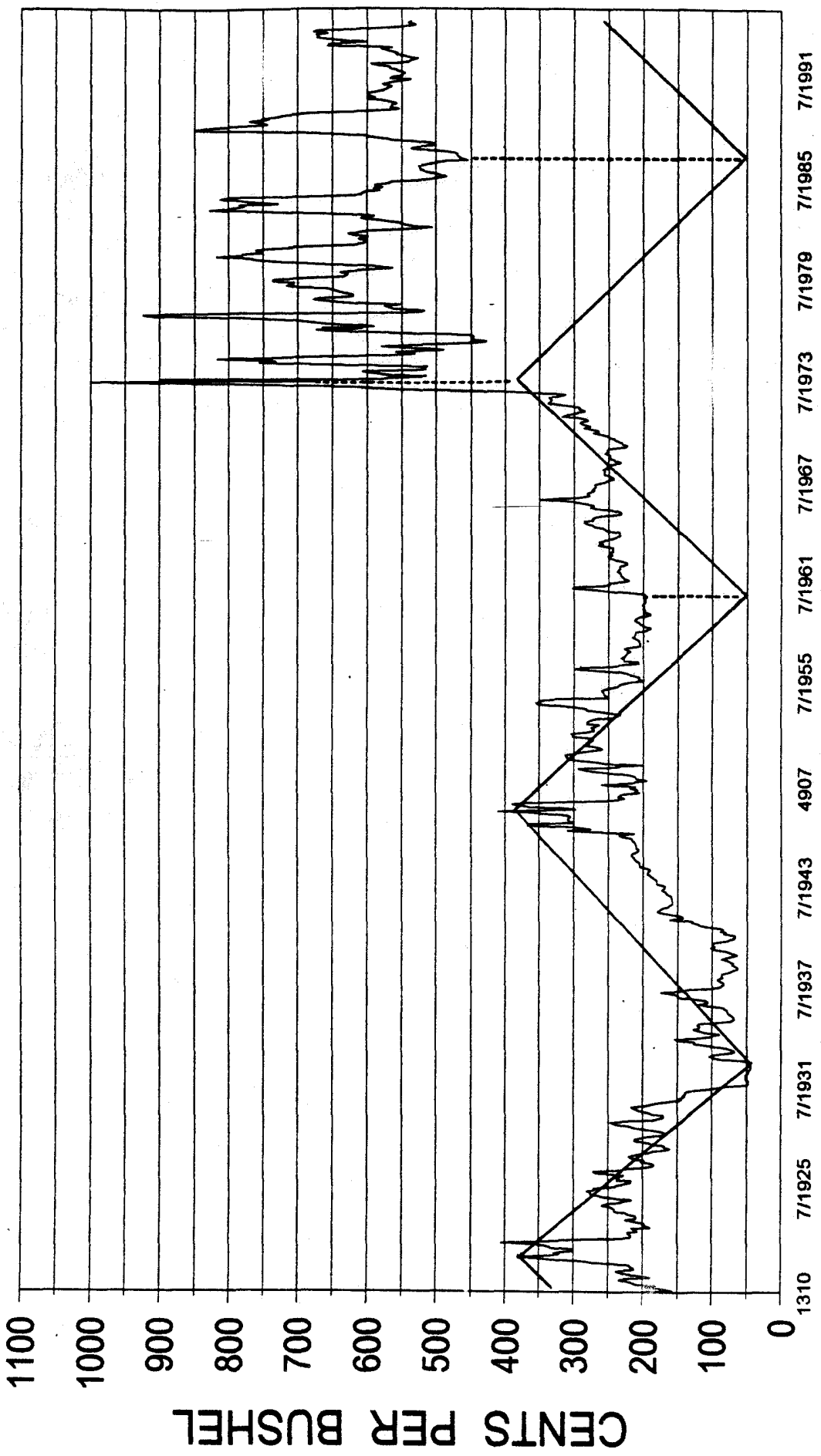

Monthly

TRADING SOFTWARE

FOR SALE & EXCHANGE

www.trading-software-collection.com

Subscribe for FREE download 5000+ trading books.

Mirrors:

www.forex-warez.com
www.traders-software.com

Contacts

andreybbrv@gmail.com
andreybbrv@hotmail.com
andreybbrv@yandex.ru

Skype: andreybbrv

ICQ: 70966433

Table 15.2 shows that when Uranus returns to 22° Aries (twenty-one years from now) it will have completed one cycle from the 1932 low, indicating that the year 2016 will be a major bottom. This cycle will be one trine from the 1986 low and 60 degrees from the top due in 2001. Of course, many readers are not interested in a projection so many years into the future and consider a "long-term" analysis one that ends next week. This attitude is a mistake because once the larger picture is understood the shorter term is much easier to predict. The analyst always needs to know the exact location of the long-term cycles before starting to work with the intermediate or short-term cycles. Waiting for a six-month cycle to top will not help much when a 28-year cycle has recently bottomed, causing prices to skyrocket.

Further evidence that prices will be decreasing in the period leading up to 2016 will be provided later in this lesson when the 29.5-year Saturn cycle is studied. This cycle is due to top in the year 2013, implying that the years between 2013 and 2016 will be similar to the 1983-1986 period.

ALTERNATING POLARITY OF URANUS TRINES

The alternating tops and bottoms associated with the two trines of the Uranus cycle create the hexagonal vortex system shown in Figure 15.1.³¹ Successive points on this hexagram have alternating polarity, causing energy to flow into and out of the system, as it rotates around the circle. This circuitous system of attraction and repulsion is the same principle upon which the electric motor is based where the alternating polarity of magnetic fields causes the rotor (central rotating part of the motor) to spin.

These fields of alternating polarity manifest in financial markets by causing prices to increase towards tops, as the excitability of the masses of men watching this particular market steadily increases, reaching the final fever pitch at the spike top. This increased energy is not only represented by increasing prices, but also in the open interest of futures contracts, as more and more men jump on board and follow the crowd. Similarly, when the point of peak excitability is passed the amount of energy decreases with prices and open interest steadily diminishing until the bottom is passed, then the process repeats itself.

³¹ When a hexagonal vortex system is viewed from the front it takes the appearance of the "Star Of David". This is similar to Figure 8.4 in *Four-Dimensional Stock Market Structures And Cycles*, which showed the shifting Mars trine in the DJIA.

Expansion Of Prices
Occur From "-" To "+"

2032
1948

Contraction Of Prices
Occur From "+" To "-"

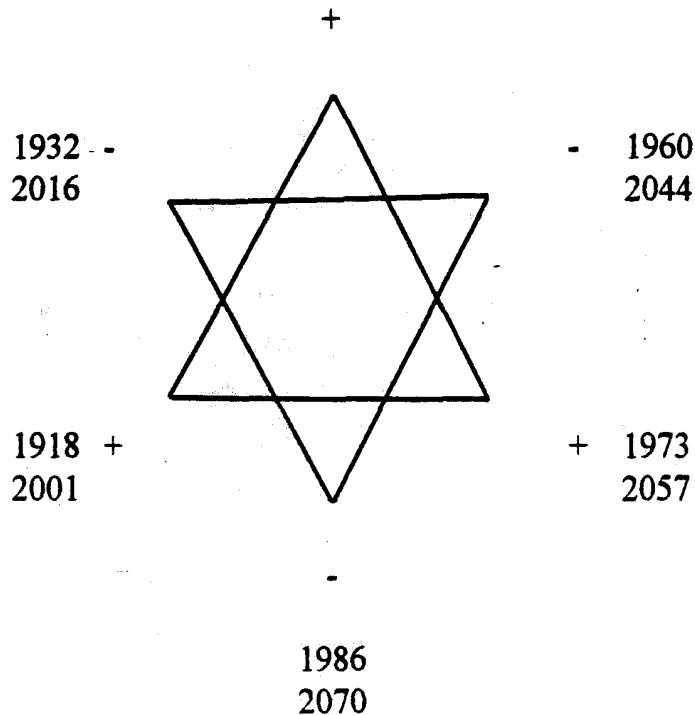

Figure 15.1

Alternating Polarity Of Turning Points Associated With Uranus Trines

One fascinating aspect of these cycles is that each financial market responds most strongly to its own particular planetary harmonic, implying that the related mass psychology is market specific. Although the cycles in the soybean market are strongly synchronized with the Uranus trine, the stock market is synchronized with the Uranus square.³²

One possible explanation for this phenomenon is that the electromagnetic disturbances in the Earth's magnetosphere, which are correlated with the different planetary configurations, affect different groups of people differently.³³ That is, the

³² Page 125 in *Four-Dimensional Stock Market Structures And Cycles* proved the correlation between the Uranus square and stock market cycles.

³³ The correlation between planetary positions and disturbances in the Earth's magnetosphere has been documented by several researchers. The most well known of these was R.N. Nelson, who worked for RCA and the National Weather Service and made predictions of radio transmission disruptions. His predictions were based on planetary positions and had an accuracy

same psychological profile found in groups of men that are attracted to a particular market is most strongly affected by a specific variation in the magnetosphere. Men who are naturally attracted to the soybean market are most sensitive to changes correlated with the Uranus trine, and less sensitive to changes correlated with the Uranus square. The opposite holds true for the stock market where men most interested in that particular market possess a psychology that, when measured in mass, is most sensitive to variations correlated with the Uranus square.

ADVANCED TOPICS - URANUS AND THE "SQUARE OF NINE"

Regardless of the market being studied, analysts will find that the Uranus cycle is closely correlated with the dominant trends. *Four-Dimensional Stock Market Structures And Cycles* provided the first example of this fact by showing the correlation of the Uranus square with trends in the stock market. This lesson provided another example by showing that the soybean market responds to the Uranus trine.

One of many reasons why Uranus has such a strong correlation with cyclic behavior on Earth, and hence financial markets, is because;

URANUS IS THE PLANET THAT "SQUARES" THE EARTH.

Its average distance from the sun is 1.786 billion miles, which is nineteen times the average distance of the Earth (92.96 million miles) from the sun. This is shown in Figure 15.2.

$$(\text{Distance of Earth from sun}) \times 19 = 92.96 \times 19 = 1.766 \text{ billion miles}$$

This factor of nineteen was referred to by W.D. Gann months before his death when he described the "Square Of Nine" in his master courses. He wrote,

"We square the Circle by beginning at 1 in the center and going around until we reach 360. Note that the Square of Nine comes out at 361. The reason for this is: It is 19 times 19, and the 1 to begin with and 1 over 360 represent the beginning and end points. 361 is a transition point and begins the next circle."

In the above quote Gann referred to 19x19 as the "Square of Nine" because it is the ninth odd square in this sequence (not counting the center square of one). This can

exceeding 90%.

Also, the correlation between variations in the magnetosphere and human physiology has been documented, most notably by Dr. Takata.

be verified by reviewing Gann's Square of Nine, shown in Figure 15.3, and counting the sequence of odd squares running along the lower left hand corners. They progress as follows:

9, 25, 49, 81, 121, 169, 225, 289, 361

These numbers are the squares of the odd integers that were presented in Lesson XIV, *Quantum Energy Levels Of Freely Traded Markets*:

$3^2, 5^2, 7^2, 9^2, 11^2, 13^2, 15^2, 17^2, 19^2$

The final value shown in this series of squared odd integers is 361 (19^2) and is the middle circle drawn on Gann's square of nine, showing that this is the square of the circle.

Also, the size of Uranus is four times (square) that of Earth. The equatorial diameter of Earth is 7,926 miles and that of Uranus is 31,750 miles.

$$\frac{31,750}{7,926} = 4.006$$

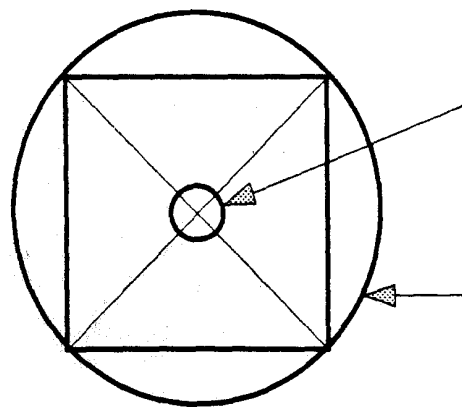

Inner Circle Represents
The Orbit Of Earth
At 92.96 Million Miles

Outer Circle Represents
The Orbit Of Uranus
At 1.786 Billion Miles

Figure 15.2

Uranus Is Nineteen Times Further From The Sun Than The Earth

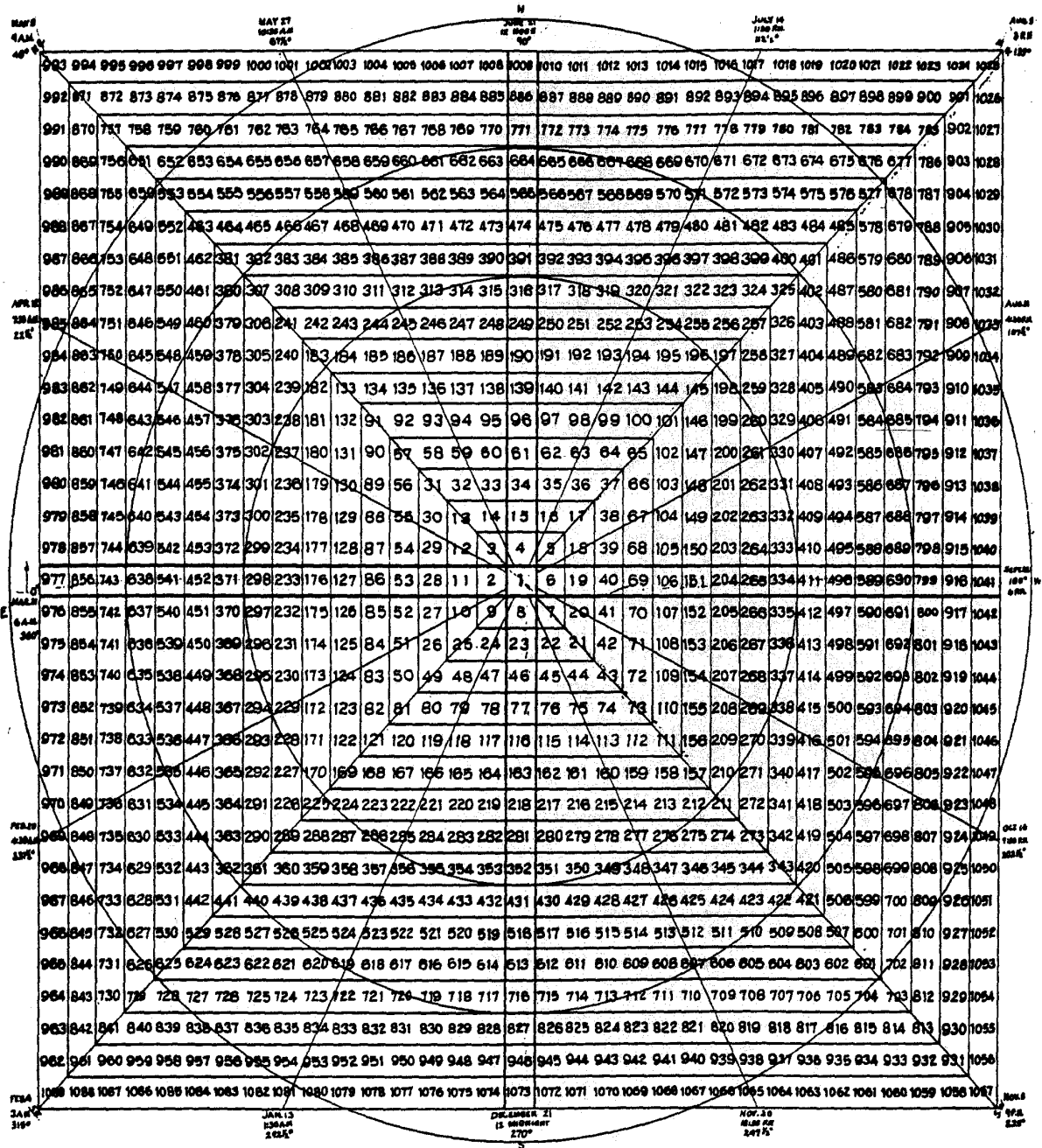

Figure 15.3
Square Of Nine

SATURN 29.5-YEAR SIDEREAL CYCLE AND SOYBEAN CORRELATION³⁴

The complete sidereal cycle of Saturn lasts, approximately, 29.5 years. This cycle is correlated with turning points in the soybean market as a sequence of alternating trends of advancing and declining prices that average 15 years.

The tops associated with the Saturn cycle are shown on Chart XV.D and in Table 15.3. Notice that each of these tops came after an even higher top that was associated with the Uranus trine, described above. For example, the top in 5/1925 was five years after the higher top in 1920, the top in 5/1954 was after the higher top in 1/1948, and the top in 9/1983 was after the higher top in 6/1973.

Another clear correlation of Saturn with soybean cycles can be seen on Chart XV.E and in Table 15.4, which show the bottoms associated with this cycle.

These bottoms are very clearly defined and occurred in 10/1940 and 10/1969. Notice that the next cycle bottom is due in the year 1999. When this is taken into consideration with the major top expected due to the Uranus trine in the year 2001, it implies that the years 1999 to 2001 will a highly explosive time.

Table 15.3
Saturn Cycle And Soybean Tops 1925 - 2013
 (See Chart XV.D)

Date Of Top	Location Of Saturn At Top	Change In Position From Last Top
5/1925	11° Scorpio	N/A
5/1954	7° Scorpio	356°
	rpio	359°
	rpio	≅ 360°

- Indici settimanali Giappone

- Produttività Giappone degli anni 80

- Pisco del Borsario

- Titolo Russia (How Times Index)

pe - China, Sibir, valde storico

is

Hc

14

to the fixed stars. A "synodic" cycle is the time planets. For example, the sidereal cycle of Jupiter 1 to the same location relative to the fixed stars. 14 years because these two planets conjoin every

be studied in this lesson.

CHART XV.D SATURN CYCLE AND SOYBEAN TOPS

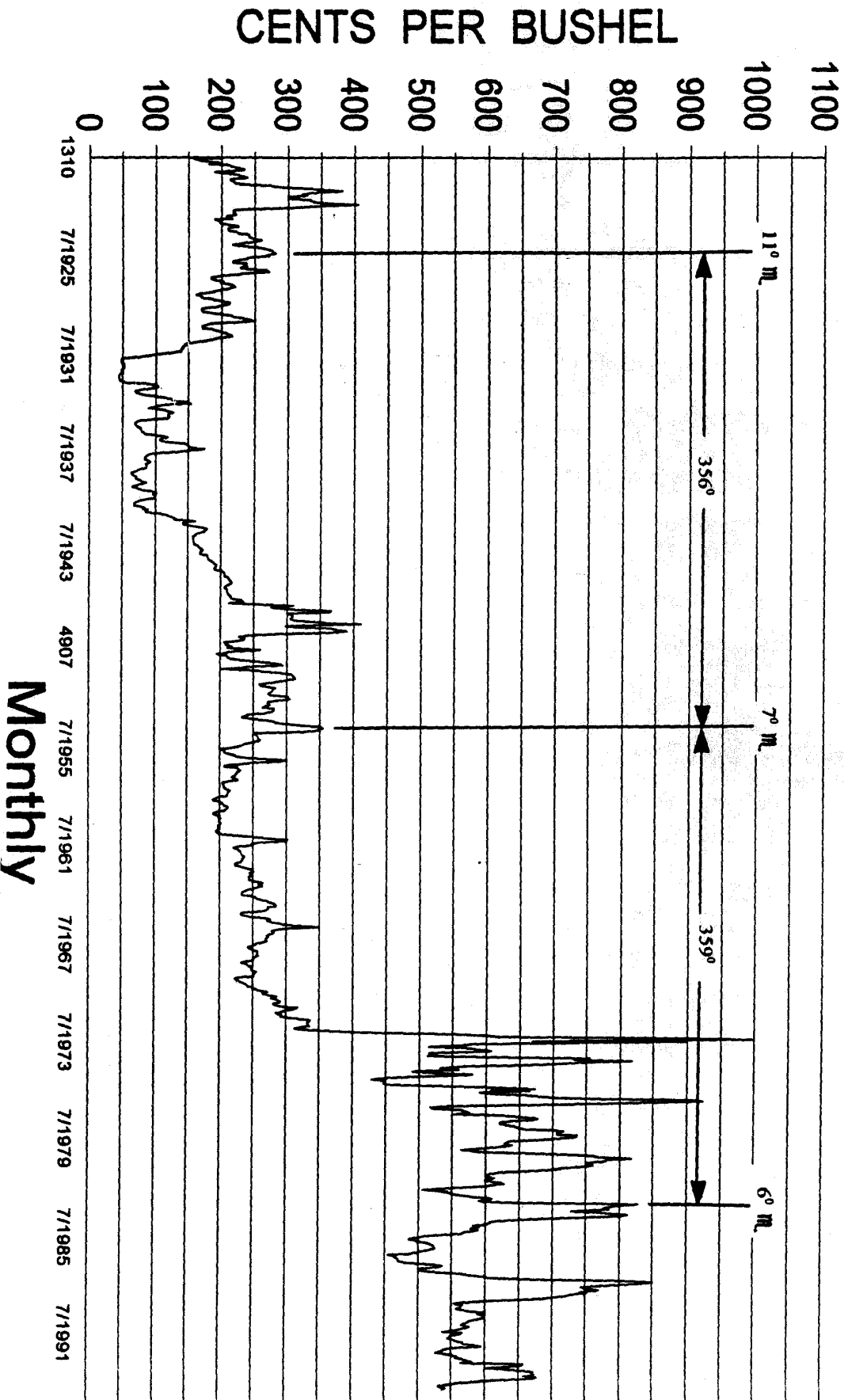
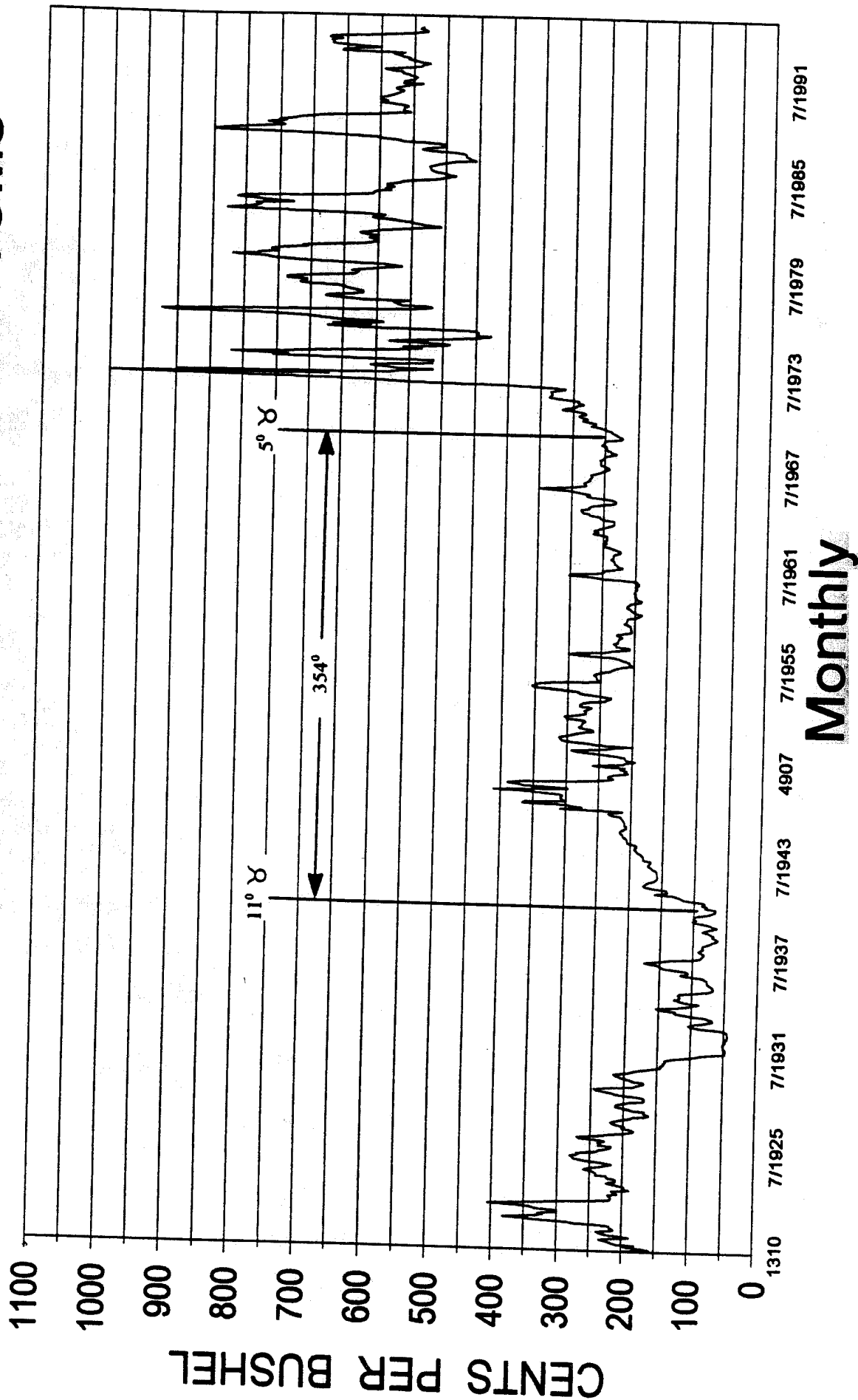

CHART XV.E

SATURN CYCLE AND SOYBEAN BOTTOMS



Because the Uranus trine and the Saturn cycle are not exactly synchronized, the time interval between the Saturn bottoms and the Uranus tops varies. The first occurrence of this combination of cycles was in the 1940's when Saturn bottomed in 10/1940 and Uranus topped in 1/1948, defining the eight-year bull market. The second occurrence of this combination was when Saturn bottomed in 10/1969 and Uranus topped in 6/1973 defining that four-year run in prices. The four-year interval was less than the previous eight-year interval in the 1940's explaining why the bottom after 10/1969 was much more vertical than in the early 1940's.

What is even more interesting is that the time interval between the 1999 Saturn bottom and the 2001 Uranus top is only two years, which is less than either of the two previous occurrences of this cyclic combination. In other words, watch out when these cycles arrive they will provide a rare opportunity to make profits (or losses if the trader is unprepared).

Table 15.4
Saturn Cycle And Soybean Bottoms 1940 - 1999
 (See Chart XV.E)

Date Of Bottom	Location Of Saturn At Bottom	Change In Position From Last Bottom
10/1940	11° Taurus	N/A
10/1969	5° Taurus	354°
~ 1999	7° Taurus	≅ 360°

SATURN-URANUS SYNODIC CYCLE AND SOYBEAN CORRELATION

Because Saturn and Uranus conjoin every 45 years, each 30 degree movement lasts an average of 45 months and the 15 degree axes average 22.5 months. Both these harmonics, the 15 and 30 degree, are closely related to soybean tops and bottoms. Since this is one of the slower moving cycles, it is correlated with long-term trends and major turning points on the weekly and monthly chart.

Chart XV.F shows the cash soybean market after completion of the 1913-1969 growth spiral. The data for the Saturn-Uranus axes shown on this chart are contained in Table 15.5. The solid vertical lines on this chart show the 30° harmonics of the Saturn-Uranus cycle and the dotted lines show the 15° harmonics. Notice how closely

CHART XV.F

SATURN-URANUS CYCLE

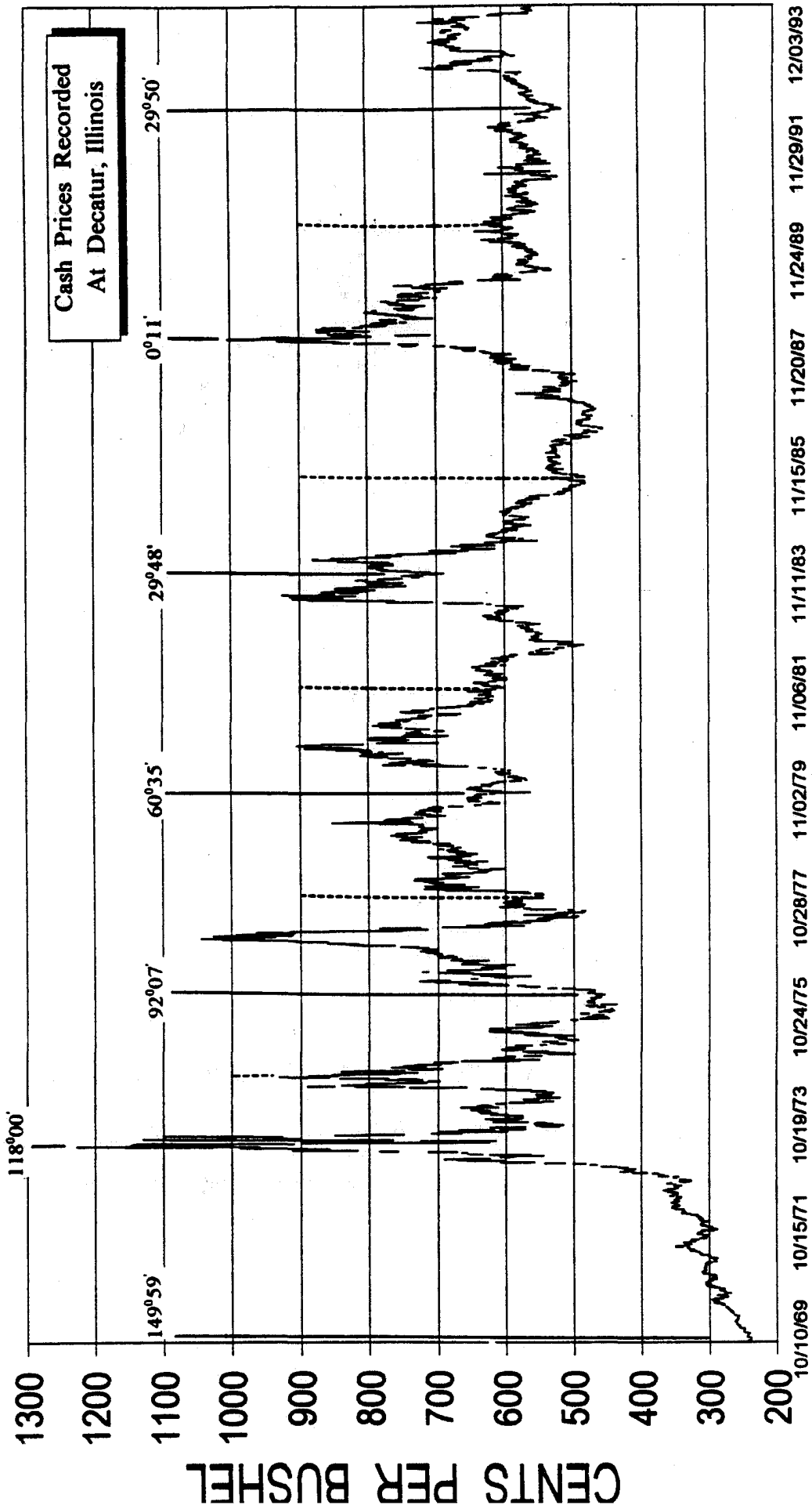

Weekly

Each turning point aligned with these axes, especially those within the last ten years. The bottoms in 1994, 1992, and 1984 were all within 12 minutes of arc, which represents about one week. Since the time between the 15 degree axes is about two years, a deviation of one week in this cycle represents less than one percent.

One of the most volatile rallies since the top in 1973 occurred in June, 1988. The top of this movement coincided with Saturn-Uranus arriving within 11 minutes of arc of a perfect conjunction. This top was EXACTLY 30 degrees from the spike bottom in 2/13/1984, 60 degrees from the bottom in 1/9/1980, and 118 degrees from the all-time high that occurred fifteen years earlier in 6/5/1973.

The most recent bottom in 10/1994 occurred within 9 minutes of arc of a perfect 45 degree angle. This position was EXACTLY 15 degrees from the bottom in 10/1992, 30 degrees from the top in 8/1990, and 45 degrees from the spike top in 6/1988.

Table 15.5
Saturn-Uranus 15° Axes And Soybean Cycles 1969 - 1996
(See Chart XV.F)

Date Of Turning Point	Angle Between Saturn-Uranus At Date Of Market Turning Point	Angular Movement Of Saturn-Uranus From Last Market Turning Point
10/2/1969	149°59'	N/A
7/19/1971	135°17'	14°42'
6/5/1973	118°00'	17°17'
10/4/1974	106°00'	12°00'
4/26/1976	92°07'	13°53'
2/9/1978	76°24'	15°43'
1/9/1980	60°35'	15°49'
12/21/1981	45°21'	15°14'
2/13/1984	29°48'	15°33'
11/21/1985	16°45'	13°03'
6/21/1988	0°11'	16°34'
8/24/1990	15°02'	14°51'
10/2/1992	29°50'	14°48'
10/7/1994	44°51'	15°01'
~ 8/1996	~ 59°	~ 15°

The next perfect 15 degree axis of this cycle arrives in August, 1996, which is very close to the typical seasonal highs for this market that usually arrives in late June or July. This angle will be 60 degrees, plus or minus a few minutes of arc, which is 15 degrees from the bottom in 10/1994, 30 degrees from the bottom in 10/1992, 45 degrees from the top in 8/1990, and 60 degrees from the top in 6/1988.

The analyst needs to be aware that these cycles rarely hit directly on the perfect angles, such as 60, 45, 30, 15 degrees. Rather, there is an "orb of influence" that has been a few minutes of arc, meaning that the top of this cycle does not have to arrive exactly in August.

JUPITER-SATURN SYNODIC CYCLE AND SOYBEAN CORRELATION

As explained in *Four-Dimensional Stock Market Structures And Cycles*, Jupiter and Saturn conjoin every twenty years, and every sixty years these conjunctions occur in the same area of the sky.³⁵ Both the twenty and sixty-year intervals show significant correlations with turning points in soybeans.

Chart XV.G shows the conjunctions of Jupiter-Saturn since the major top in 1920. Because every third conjunction of these two planets occurs in the same area of the sky, the conjunction that is due in the year 2000 will occur in Taurus, as it did at the major bottom in 1940. This adds another element to this potentially explosive period. During this time, Saturn returns to Taurus in the 30-year cycle, Uranus reaches its trine from the 1973 top (in 2001), and Jupiter-Saturn conjoin, making this a very interesting time for traders. In addition to the volatile market conditions that will exist around the turn of the century, the reader should review Appendix F in *Four-Dimensional Stock Market Structures And Cycles*, to see how dangerous this time is for war. Keep in mind that World War I started in the geographic area now called Bosnia where the current tensions are so high.

In addition to the 20-year cycle that is associated with the Jupiter-Saturn conjunction, the other major Jupiter-Saturn harmonics are also present in this market. One cycle of significant strength is the 60 degree harmonic. This cycle can be seen on Chart XV.H and in Table 15.6, which contains the data. Examples of this 60 degree interval are:

- (1) the bottom in 5/6/1974 was 58⁰03' from the top in 4/22/1977
- (2) the top in 4/22/1977 was 60⁰17' from the top in 11/21/1980
- (3) the top in 11/21/1980 was 57⁰20' from the top in 5/21/1984
- (4) the top in 9/21/1983 was 60⁰33' from the bottom in 10/7/1986
- (5) the top in 7/3/1990 was 60⁰12' from the top in 1/13/1994

³⁵ Reference Figure D.1 in *Four-Dimensional Stock Market Structures And Cycles*.

CHART XV.G

JUPITER-SATURN CONJUNCTIONS

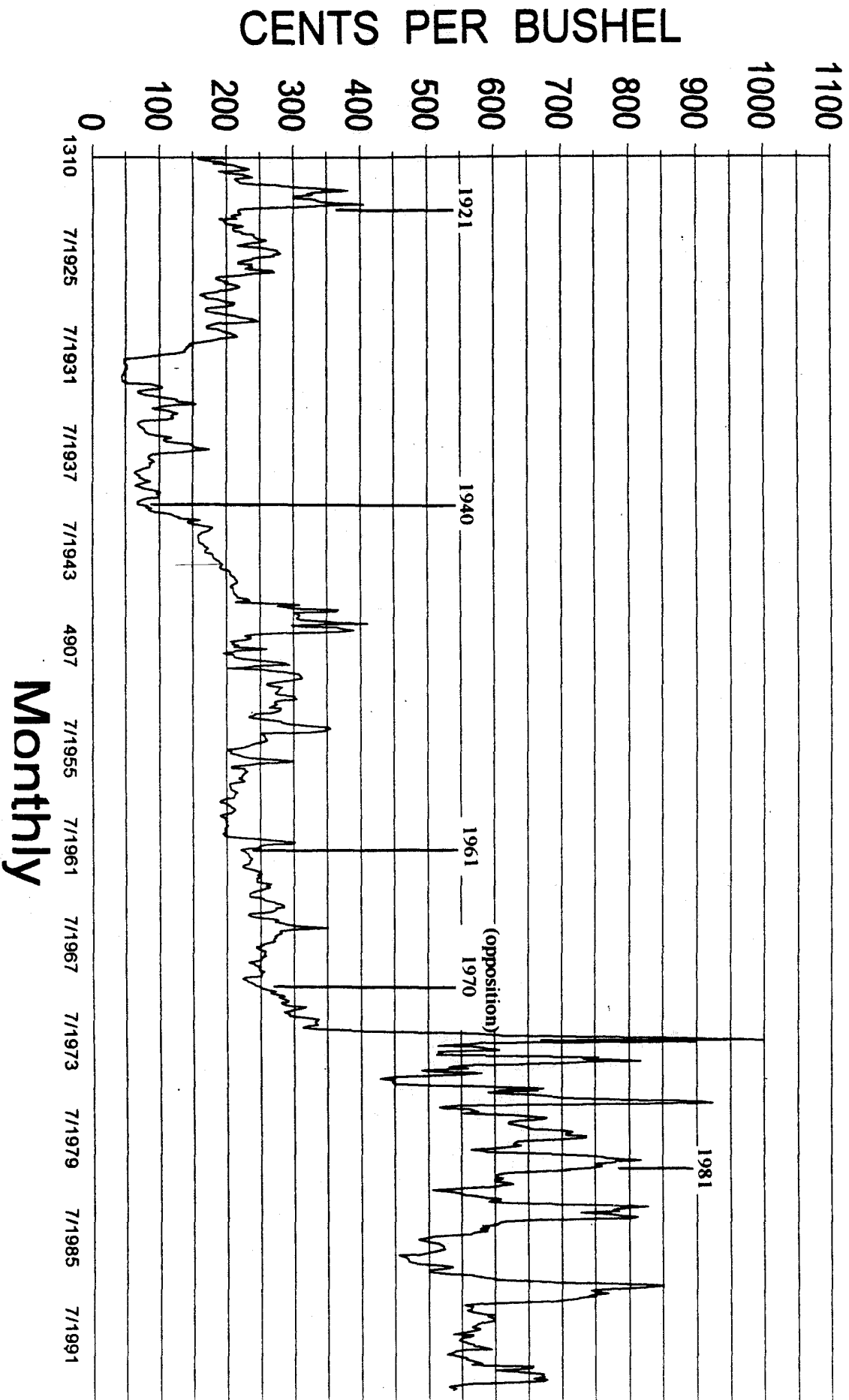
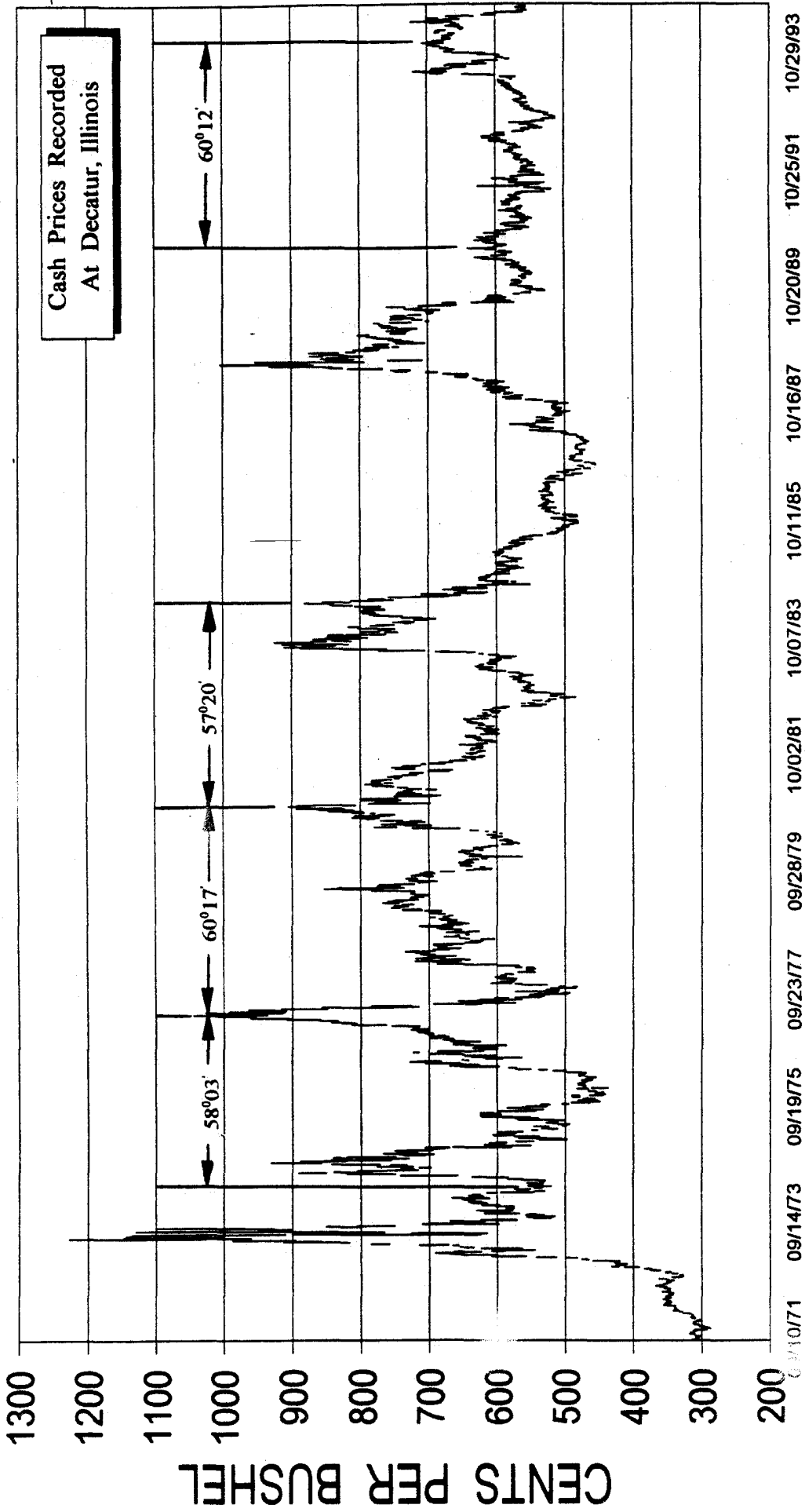

CHART XV.H

JUPITER-SATURN CYCLE



Weekly

The 45 degree (and 22.5) harmonic is also strong in the cycle. For example, the tops in 11/21/1980 and 9/21/1983 were separated by $45^{\circ}25'$. Also, the top in 11/21/1980 was $22^{\circ}22'$ from the top in 6/22/1979, as was the last major top preceding 6/22/1979.

Table 15.6
Jupiter-Saturn Harmonics And Soybean Cycles 1973 - 1994
 (See Chart XV.H)

Date Of Turning Point	Angle Between Jupiter-Saturn At Date Of Market Turning Point
6/5/1973	141 ^o 22'
5/6/1974	124 ^o 30'
1/26/1976	91 ^o 52'
4/22/1977	66 ^o 27'
10/20/1977	57 ^o 14'
6/22/1979	28 ^o 32'
11/21/1980	6 ^o 10'
10/4/1982	23 ^o 04'
9/21/1983	39 ^o 15'
2/13/1984	46 ^o 17'
5/21/1984	51 ^o 10'
9/20/1984	58 ^o 25'
10/7/1986	99 ^o 48'
9/1/1987	120 ^o 00'
6/21/1988	137 ^o 48'
1/4/1989	149 ^o 34'
10/13/1989	165 ^o 33'
7/2/1990	179 ^o 50'
1/13/1994	119 ^o 58'

WWW.FOREX-WAREZ.COM
ANDREYBBRV@GMAIL.COM SKYPE: ANDREYBBRV

Notice that the tops in 6/5/1973, 4/22/1977, and 9/21/1983 were all just over six degrees from a perfect 15 degree axis. This is called the "orb-of-influence". For example, the top in 1973 was at $141^{\circ}22'$, which is $6^{\circ}22'$ from the 135 degree harmonic. The top in 1980 was at $6^{\circ}10'$, which is $6^{\circ}10'$ from the conjunction. And the top in 9/21/1983 was at $39^{\circ}15'$, which is $5^{\circ}45'$ from the 45 degree axis.

Proficiency in this type of analysis should be a goal for market analysts because it takes a certain amount of experience to know how to measure harmonics from many different points and using different cycles to identify a high probability axis in the future. The author could continue to show the 15 degree axes of this cycle, but more benefit would be obtained by the reader if he did some of this work himself.

JUPITER-URANUS SYNODIC CYCLE AND SOYBEAN CORRELATION

Jupiter and Uranus conjoin every 14 years. This cycle and its harmonics are very closely correlated with turning points in a variety of markets, including soybeans. Two very important harmonics of the Jupiter-Uranus synodic cycle are those that divide along the 15 and 22.5 degree (or 45 degree) axes. These two cycles and the minor planetary cycles associated with their sub-harmonics were explained in detail in *Four-Dimensional Stock Market Structures And Cycles*.

45 and 22.5 Degree Harmonics Of The Jupiter-Uranus Cycle

A specific review of the 45 and 22.5 degree harmonics is included in this work, not only because of its direct applicability to soybean market timing, but also, because it is one of the cycles that was discovered by the author and published in *Four-Dimensional Stock Market Structures And Cycles* that has recently appeared in other market timing publications. After the editor of one such publication consulted with the author of this work and was told to look for the 45° harmonic beginning from the 10/1989 low, a "sawtooth"³⁶ waveform was published by that editor with a periodicity correlated with the 22.5 and 45 degree axes. This harmonic can be seen on Chart XV.I where alternating trends of advancing and declining prices since 1989 have been associated with 22.5 degree harmonics of Jupiter-Uranus. The data shown on this chart are contained in Table 15.7.

Although this harmonic was very closely correlated with alternating tops and bottoms during this time, this is not always the case. There are certain times when this cycle fits into a sawtooth waveform and times when it does not. For the analyst to

³⁶ The term "sawtooth" is slang for a waveform that advances at a constant rate until the peak is reached then declines at a constant rate. It is sometimes called a "triangle" waveform.

CHART XV.1

JUPITER-URANUS 45 DEGREE HARMONIC

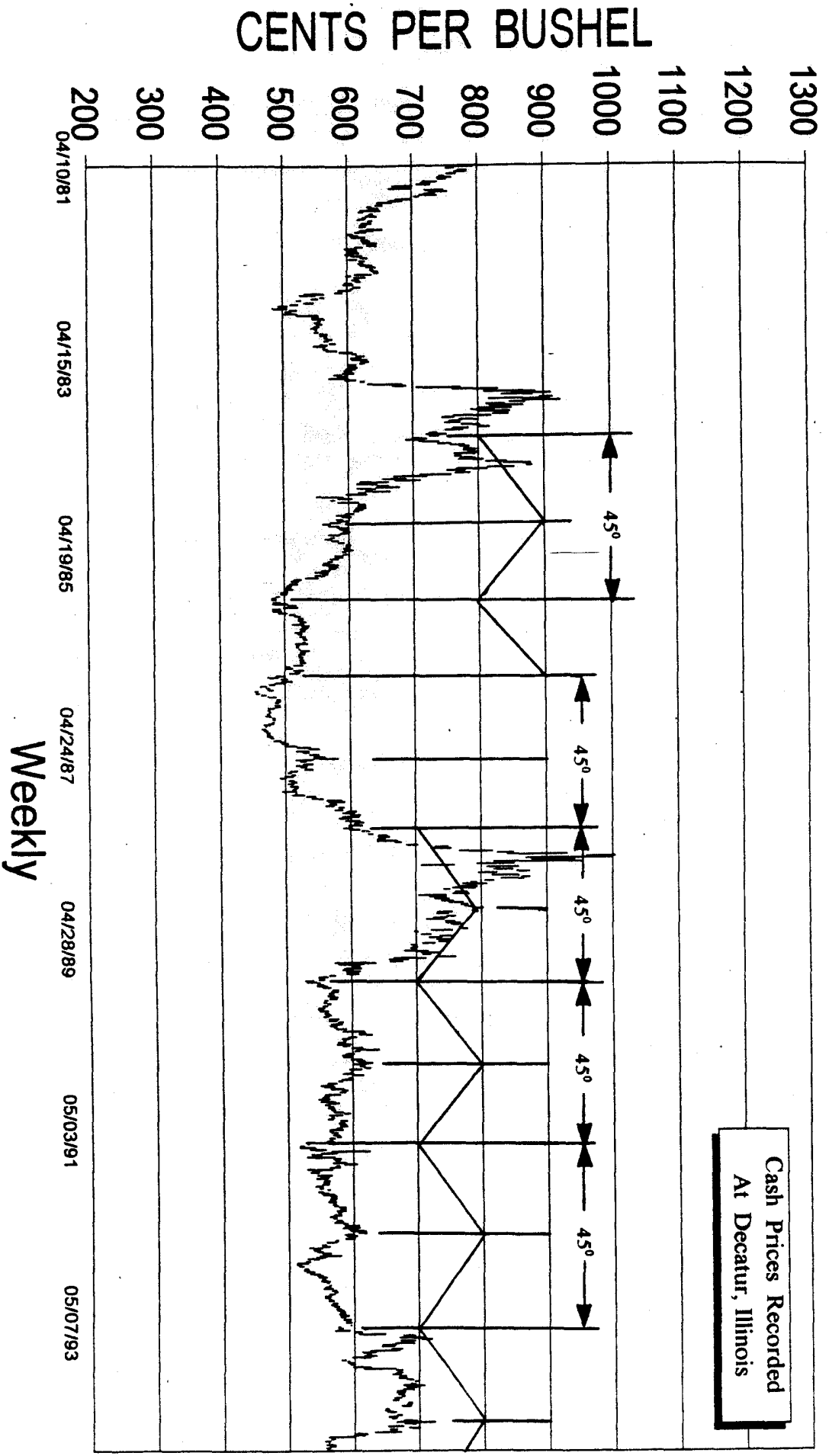

determine when to expect alternating tops and bottoms along the 22.5° axes, a better understanding of the relationships between this and other cycle harmonics must be mastered. Unfortunately, the author is unable to provide the reader with the conditions that determine when this harmonic is associated with a top and when it is associated with a bottom because that information would be immediately published by others who will undoubtedly read this material.

Table 15.7
Jupiter-Uranus 22.5° Axes And Soybean Cycles 1984 - 1996
 (See Chart XV.I)

Date Of Turning Point	Angle Between Jupiter-Uranus At Date Of Market Turning Point	Angular Movement Of Jupiter-Uranus From Last Market Turning Point
2/13/1984	$16^\circ 37'$	N/A
1/4/1985	$39^\circ 39'$	$23^\circ 02'$
10/28/1985	$61^\circ 45'$	$22^\circ 06'$
8/12/1986	$83^\circ 53'$	$22^\circ 08'$
5/14/1987	$105^\circ 58'$	$22^\circ 05'$
3/10/1988	$129^\circ 56'$	$23^\circ 58'$
1/4/1989	$153^\circ 26'$	$23^\circ 30'$
10/13/1989	$174^\circ 47'$	$21^\circ 21'$
8/24/1990	$162^\circ 27'$	$22^\circ 46'$
7/11/1991	$140^\circ 23'$	$22^\circ 04'$
6/9/1992	$118^\circ 15'$	$22^\circ 08'$
6/15/1993	$94^\circ 15'$	$24^\circ 00'$
5/23/1994	$72^\circ 14'$	$22^\circ 01'$
5/9/1995	$49^\circ 00'$	$23^\circ 14'$
~ 4/1996 (top or bottom ?)	~ 27°	~ $22^\circ 30'$

One clear example when the 22.5° harmonic was not correlated with alternating tops and bottoms can be seen on Chart XV.I where the 45° harmonics are shown by solid vertical lines and the 22.5° harmonics with dotted lines. The cycles between 10/13/1989 and 5/23/1994 followed a clear sawtooth waveform evenly spaced 45° from bottom-to-bottom and from top-to-top. However, a phase shift occurred between the bottom in 10/13/1989 and the bottom in 10/28/1985 when the angle between Jupiter and Uranus was $61^{\circ}45'$. This can be verified by noting that Jupiter-Uranus moved $113^{\circ}02'$ between the bottom in 10/28/1985 and the bottom in 10/13/1987. If this cycle was following a perfect sawtooth the spacing of 113° should represent the interval between a bottom and a top ($45 + 45 + 23 = 113$). It must also be noted that prior to the bottom in 10/28/1985, the bottoms were again spaced 45° apart. Analysts not expecting this phase shift would have been waiting for a top in 10/13/1989 when Jupiter-Uranus had moved 113° from the bottom in 10/28/1985. However, this date marked a bottom.

The problem that must be resolved is when the next phase shift is expected because when that occurs an anticipated top may actually be a major bottom.

The example cited above shows one example of the dangers of reaching hasty conclusions without a full understanding of the subject matter.

30 And 15 Degree Harmonics Of Jupiter-Uranus Cycle

The fifteen and thirty degree harmonics are at least as valuable as the 22.5 degree harmonics in identifying and predicting cycles in soybeans. The fifteen degree harmonics divides the larger 45° harmonic into three parts, whereas the 22.5 degree harmonics divides it into two parts.

Chart XV.J shows the cash soybean market since the bottom in 10/1989. The data for this chart are contained in Table 15.8. Notice that when this cycle is measured along the 30 degree axes, instead of the 15 degree, it is very closely associated with turning points, usually within a few minutes of arc. For example, the bottoms in 7/11/1991 and 10/2/1992 were $29^{\circ}57'$ apart ($140^{\circ}23' - 110^{\circ}26' = 29^{\circ}57'$), the distance between the top in 5/9/1989 and the bottom in 7/11/1991 was $29^{\circ}42'$, and the distance between the bottom in 10/2/1992 and the top in 1/13/1994 was $29^{\circ}47'$. These deviations from the perfect 30 degree angle represent only a few trading days.

Charts XV.F and XV.J show why the market bottomed in 10/1994. Not only was Saturn-Uranus at a 45 degree angle, but Jupiter-Uranus were also at their 60 degree axis. This time was also very volatile for the stock market.

CHART XV.J

JUPITER-URANUS 15 DEGREE HARMONICS

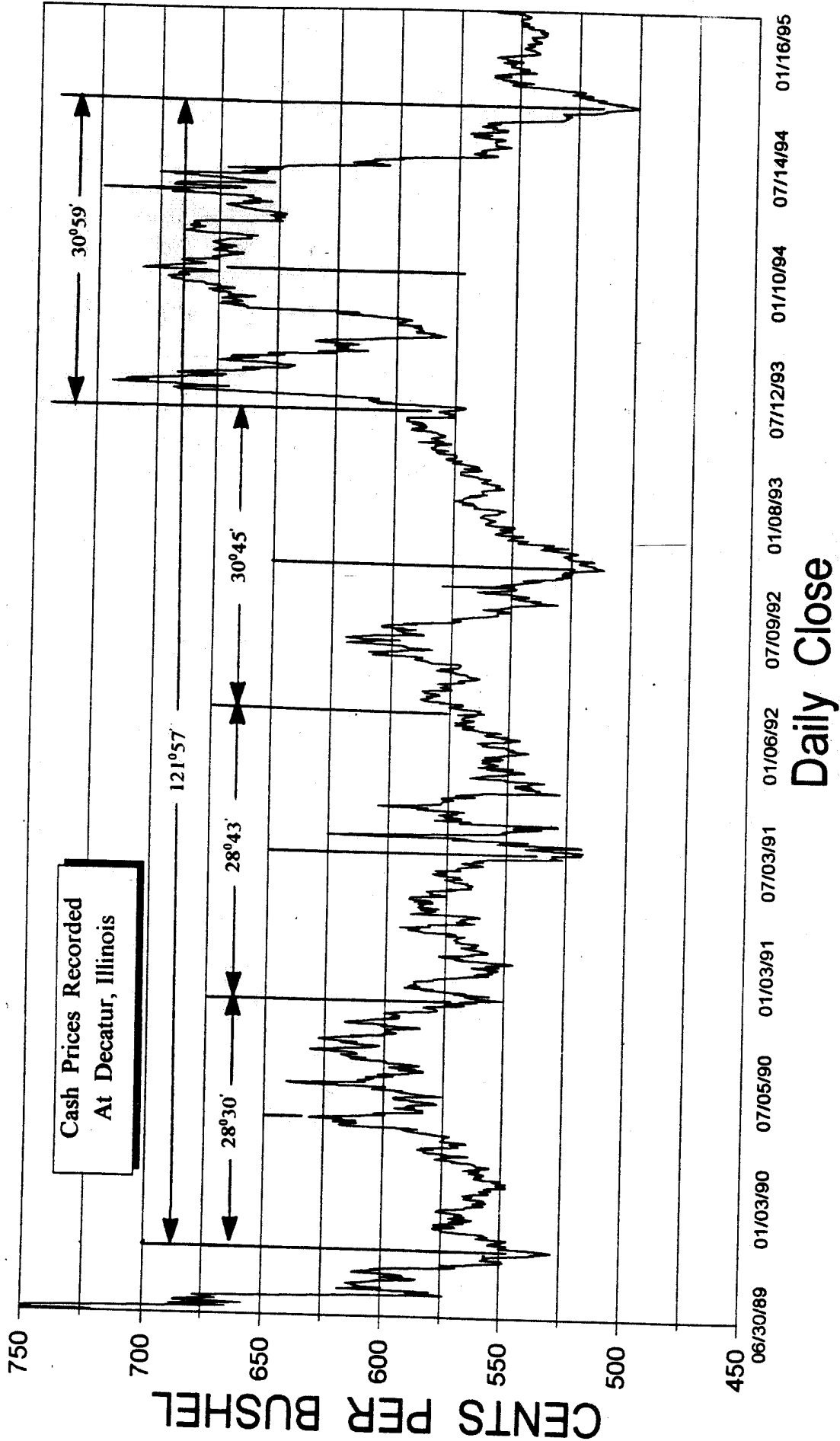

Table 15.8
Jupiter-Uranus 15° Axes And Soybean Cycles 1989 - 1994
 (See Chart XV.J)

Date Of Turning Point	Angle Between Jupiter-Uranus At Date Of Market Turning Point	Angular Movement Of Jupiter-Uranus From Last Market Turning Point
10/13/1989	174°47'	N/A
5/9/1989	170°05'	15°08'
11/14/1990	156°43'	13°22'
7/11/1991	140°23'	16°20'
2/13/1992	125°00'	15°00'
10/2/1992	110°26'	14°34'
6/15/1993	94°15'	16°11'
1/13/1994	80°39'	13°36'
10/7/1994	63°16'	17°23'

If the reader will extend this analysis back in time before the bottom in 1989 he will see that this harmonic is extremely accurate in timing soybean turning points. The dates to look for include:

10/4/1982	-	16°28'
6/29/1983	-	1°09'
2/13/1984	-	16°37'
9/20/1984	-	31°56'
10/7/1985	-	60°08'
10/7/1986	-	88°28'
5/14/1987	-	105°58'
10/19/1987	-	118°31'
6/21/1988	-	138°03'

One advantage in using the Jupiter-Uranus cycle is its high reliability. This is the case in many markets other than soybeans and stocks.

CONCLUSION

Lesson VI, *Sympathetic Resonance And The Law Of Vibration*, in *Four-Dimensional Stock Market Structures And Cycles* stated,

"In order to accurately time a financial market, it is simply a matter of finding with what other element in nature the particular market has synchronized, then determining if this other element provides predictability."

That work went on to show the correlation between the Uranus square and the Dow Jones Industrial Average. The strong response of the stock market to the Uranus square is because that square is closely synchronized with the stock market's natural resonant frequency. Because every body in nature has its own specific resonant frequency, each market tends to be most strongly synchronized with different harmonics of the planetary cycles. For example, some markets may respond strongly to the Jupiter-Saturn fifteen degree axes, while others only show weak reactions to these harmonics.

Although the stock market resonates strongly with the Uranus Square, the cycles in the soybean market are closely synchronized with the Uranus trine. This lesson proved that fact by verifying the correlation between the long-term alternating trends in the soybean market and sixty degree movements of Uranus. Further evidence of this planetary relationship was provided by showing that these soybean tops and bottoms were not evenly spaced in time, sometimes the interval was 25 years and other times it was 30 years. This deviation from the fixed or "static" cycle is due to the fact that Uranus moves in an elliptical orbit, causing varying amounts of time to elapse between its sixty degree axes. Although the spacing between these tops and bottoms varied from 25 to 30 years, the Uranus trine was closely correlated with all of them.

The trine of the Uranus cycle arrived at the 1918, 1948, and 1973 tops. Similarly, the opposing trines defined the 1932, 1960, and 1986 bottoms. This cycle is due to top again in the year 2001. Price movements associated with this top have typically been vertical with a quick collapse after the top has been hit.

Adding to the excitement of the 1999-2001 period are the facts that Jupiter and Saturn conjoin during this time, as they did in 1940, 1960, and 1980. Also, Saturn returns to the same location in Taurus, as it did at the bottoms in 1940 and 1969. There are similarly interesting things happening with the other planetary cycles during this time.

As with most markets, the Saturn-Uranus harmonics are important for timing soybean cycles. This cycle played a role in many of the turning points, including the major tops in 1973 and 1988, as well as the most recent bottom in 10/1994 when their angle was 45° . The next axis of this cycle is due in July, 1996 at sixty degrees.

The strongest correlation between soybean cycles and the Jupiter-Saturn cycle is with the harmonics of sixty degrees and its integral multiples, such as 120 and 180.

Analysis of the time period prior to 1989 showed that there was a six degree "orb-of-influence" associated with this cycle. However, more recent turning points in 10/1989, 7/1990, and 1/1994 have been within one-half of one degree from the natural angle.³⁷

One of the most important cycles in this market, as well as others, is that of Jupiter-Uranus. Soybeans resonate very strongly with both the 15 and 22.5 degree harmonics of this cycle. The trader may want to focus his attention on this cycle for his "position trading" of several weeks or longer because a fifteen degree movement of this cycle averages seven months.

Although this lesson only looked at the long-term planetary cycles, the reader will find strong correlations between turning points on much smaller time scales if the cycles of the inferior planets are studied. Specifically, measure the angles between these faster moving planets at key market turning points and then see how far their sidereal and synodic cycles move until the next turning point is reached. This will identify the dominant resonant cycles on much smaller time scales than is possible with the superior planets.

Another consistent characteristic of this market is the seasonal high that is typically made in July and the seasonal low made in October. Traders could make significant profits just by buying in October and selling in June or July. Especially, when one of the planetary axes arrives during one of these months.

So the general rule of thumb is to be short in August and September.

³⁷ The cause of shifting of the orb-of-influence was explained in detail in *Four-Dimensional Stock Market Structures And Cycles*.

LESSON XVI

SQUARE OF FIFTY-TWO

The Square of 52, which is composed of 7-day periods, is one of the most important for measuring Price and Time.

... *W.D. Gann, Master Course For Commodities*

INTRODUCTION

W.D. Gann wrote in both his *Master Course For Stocks* and *Master Course For Commodities* that the square of fifty-two was the "Master Calculator to determine the trend of stocks and commodities". Although the origin of Gann's discovery of this square is unknown, there is a remarkable similarity between his writings and the calendar systems used by the ancient Maya and Aztecs.

This lesson will study the calendars of the Aztecs and Maya and show that the same time intervals used in their calendar and number systems are those defining the dominant long-term cycle in the soybean market. This time cycle is closely correlated with planetary cycles.

This lesson does not look at the vectorial applications of the square of fifty-two and was only included in this volume of *Market Science* because of its applicability to the planetary cycles studied in Lesson XV. Therefore, only the dimension of time will be studied in this lesson. If the reader chooses to research this square using PTVs™ he should be aware that when studying the spatial arrangement of points of force in growth spirals of the soybean market better results are obtained using the square of twelve.

MESOAMERICAN CALENDARS

The Mesoamericans, particularly the Aztecs and Maya, used two calendars, one based on 260 days and the other on 365 days.³⁸ The 260-day interval was divided in 18 groups of twenty and the 365-day interval was grouped into 20 groups of thirteen with five extra days added at the end. There is much speculation about why they chose the 260-day time interval, which the Maya called the "tzolkin" or "Sacred Year".

³⁸ Recently, the author was in the Yucatan peninsula of Mexico studying the ancient Mayan pyramids. Evidence that the Aztecs and Maya were constantly at war can be seen by the modifications that were made to these pyramids by the Aztecs after the Maya built them. This explains the great similarity between the two calendar systems of these cultures.

Suggestions range from the time between conception and birth in the human reproductive cycle to one of many astronomical correlations.³⁹

This 260-day calendar was considered so sacred that the "common" people were not allowed to know exactly what day within the interval it was. Only the shaman or high priests knew the precise day count at any particular point in time.⁴⁰

The 365-day cycle was called the "haab" by the Maya and "xiuhpohualli" by the Aztec. The Mayan day was called the "kin" and 360 kins were called the "tun". Therefore,

THE DIFFERENCE BETWEEN THE HAAB AND THE TUN WAS FIVE DAYS.

Both these Mesoamerican cultures divided the 360-day interval into eighteen 20-day sections. This was quite likely done because they used a vigesimal number system based on 20. When twenty days were grouped together they were called a "uinal". Therefore, 18 uinals equaled one 360-day tun.

In summary, the breakdown of the Mayan 360-day interval is as follows:

$$\begin{aligned} 20 \text{ kins (days)} &= 1 \text{ uinal} \\ 18 \text{ uinals} &= 1 \text{ tun (360 days)} \end{aligned}$$

In addition to these daily calendars, the Maya also used a 260-year calendar that was based on 13 conjunctions of Jupiter and Saturn, which occurs every twenty years. Notice the recognition by the Maya that there were natural time divisions and that a time count found in one, such as days, is also found in another, such as years. This same principle is found in financial markets where both the 52-week cycle and the 52-year cycle exists. The Maya grouped the yearly time intervals as follows:

³⁹ Another wonderful entry in the history of Catholicism is the contribution made by the bishop of Yucatan in 1549, Diego de Landa, who ordered all the Mayan documents to be publicly burned because he could not understand them and hence, considered them the work of the devil. The amount of knowledge that was forever lost because of this foolishness will never be known.

Certain manuscripts survived and were sent to the Vatican, where they are archived, unavailable to the public.

⁴⁰ Doomsdayers may want to know that the beginning of the Maya calendar was, approximately, 5,200 years ago. The complete cycle is 260 years x 20. This cycle completes on December 23, 2012, which according to the Maya portends doom.

Although the author maintains a 260-day calendar for his own use, he does not subscribe to the philosophy of the inevitable destruction of mankind.

360 kins (days)	=	1 tun
20 tuns	=	1 katun (one Jupiter-Saturn synodic cycle)
20 katun	=	1 baktun (approximately 400 years)

These baktun were further grouped into 13 sections creating the Mayan Great Cycle of approximately 5,200 years. Archaeologists studying this calendar have found that the Maya used a value for the Jupiter-Saturn cycle that differed by only one-half of one day from the best measurements our modern instruments can make.

All the information presented above is necessary to understand how the square of fifty-two is derived from the elemental units of 260 and 365.

**IT IS THROUGH THE PROCESS OF SYNCHRONIZING THE
260-DAY CALENDAR WITH THE 365-DAY CALENDAR THAT
THE 52-YEAR CYCLE ARISES.**

Because these two calendars were running simultaneously, any single day was given a name from both calendars. Therefore, it was 18,980 days (52 years x 365 days/year = 18,980 days) before a day's complete name would repeat. The value of 18,980 days is the least common multiple between 260 and 365 days and coincided with 73 years of the "Sacred Calendar" of 260-days and 52 years of the 365-day calendar.⁴¹ In other words, it is only after 52 years that the 260 and 365-day calendars return to the same day in both calendars.

The Aztecs called this 52-year interval the "Bundling of the Years" and celebrated it with the "New Fire" ceremony. However, this time was not necessarily one of great joy with either the Aztecs or Maya because they considered that it may be the time when the world would end. They did many of their infamous human sacrifices during this time. The celebrations became especially wild on even multiples of this cycle, such as 104 years, which is 146 years on the 260-day calendar (73 x 2 = 146). The sixth recurrence of this cycle happened every 312 years, which the Maya considered to be a particularly dangerous period.

The 52-year cycle was divided into four (square) 13-year cycles. This was because the 20 day-names divide into the 365-day year 18 times with five left over and

⁴¹ *Square Of Twelve* demonstrated the significance of the value of 72 to financial markets because it is half the square of twelve.

five divides back into 20 four times. Therefore, the first day-name of the year rotates between four possibilities. These four day-names were called "year bearers" and were repeated 13 times in the 52-year cycle.

Even today, certain descendants of the ancient Maya in the Yucatan peninsula perform tributes to this 52-year cycle and its 13-year quarter.

The following section will show that it is this 13-year section that is an extremely important trend determinant in the soybean market.

SQUARE OF FIFTY-TWO AND THE SOYBEAN MARKET

W.D. Gann wrote about the square of 52 in both his *Master Course For Stocks* and *Master Course For Commodities*, where it was applied to the weekly chart.

In the same section of his master courses that he explained the square of 52 he also provided his brief writings about the "fourth dimension" in financial markets. However, the extent of Gann's knowledge on this subject, and where he learned it, is speculative.⁴²

Obviously, the square of 52 is applicable to the weekly chart because this time interval defines one year and one-fourth of 52 is 13 weeks, which is the length of the four seasons (square) on Earth and the period of Mercury. *Four-Dimensional Stock Market Structures And Cycles* explained in detail the importance of this cycle.

It is assumed that the reader is already familiar with the weekly applications of this square and therefore, the following description will use the yearly time interval for both the 52 and 13-year cycles.

Chart XVI.A shows the complete historical record of the soybean market with the top graph shifted 26 years forward in time. Shifting the chart like this allows a comparison between the patterns after a 26-year interval.

This chart clearly shows the recurring patterns at the half-way point of the square of 52.

⁴² W.D. Gann wrote in his master courses,

"The Calculator is 104 weeks wide, which equals 2 years. The time periods run across the bottom of the Calculator from left to right to 104, which completes 2 years, and to 208, which completes 4 years. At the top of the Calculator, running across to the left, the time periods run to 312 which ends 6 years, and to 416, which ends 8 years, and to 520, which completes a 10-year cycle."

WWW.FOREX-WAREZ.COM
ANDREYBBRY@GMAIL.COM SKYPE: ANDREYBBRY

CHART XVI.A

SQUARE OF FIFTY-TWO

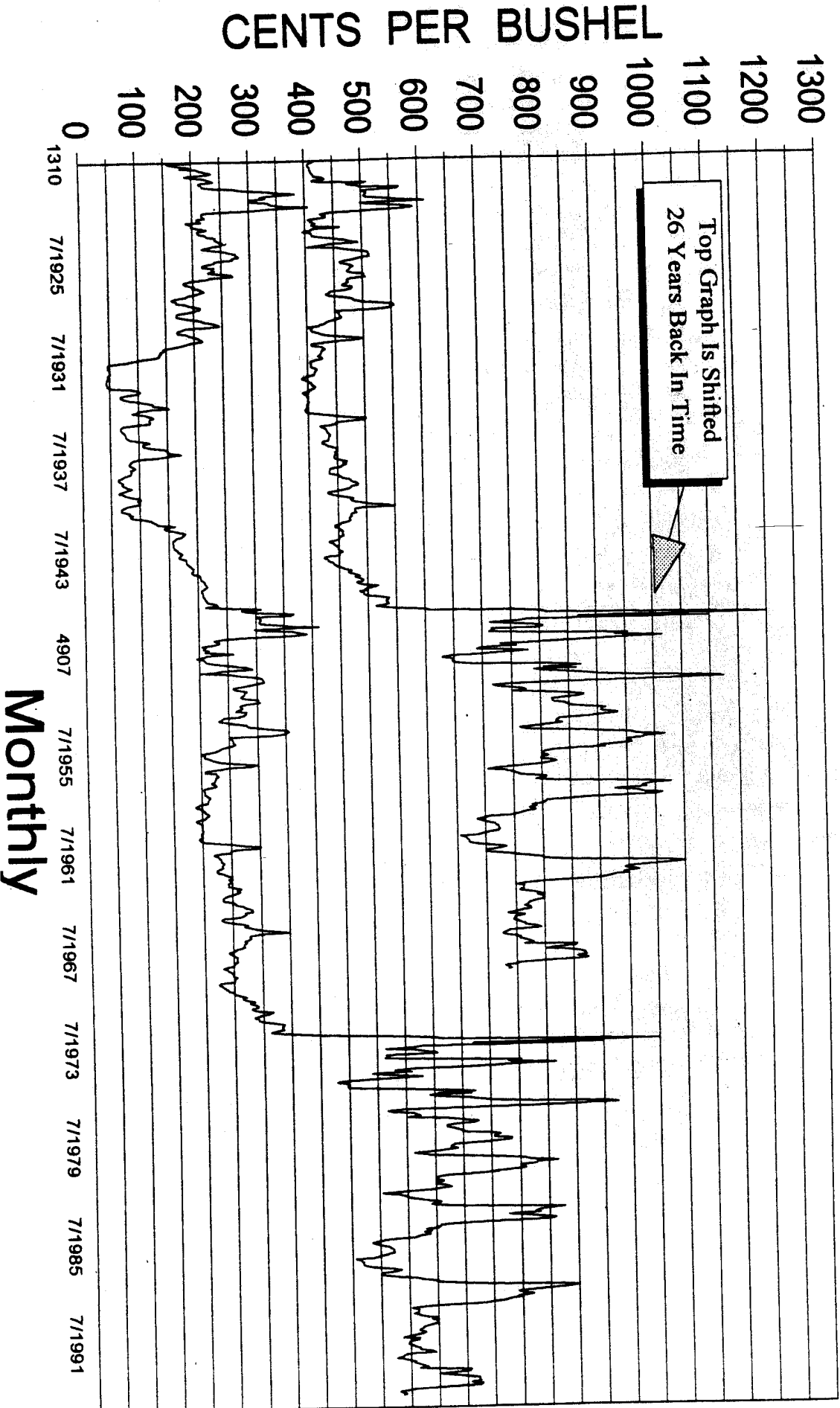

13-YEAR INTERVAL IN THE SOYBEAN MARKET

Thirteen is one of the well-known Fibonacci numbers and defines the duration of many of the significant bull and bear markets in the soybean market.⁴³ This cycle is one-fourth of the square of 52.

Chart XVI.B shows the three major declines in the soybean market correlated with the 13-year cycle that have occurred since 2/1920. Because between 1913 and 1924 data was only collected for the months between October and February, this chart represents trading months and not calendar months. Charting the available data in this fashion compresses the chart during this time, explaining the difference seen in the alignment of the cycles. Using "calendar months" and not "trading months" in order to see the direct celestial correlations is helpful because the planets keep moving regardless of whether or not market data is being collected.

The first decline shown on Chart XVI.B was from the top in 2/1920 to the all time low in 12/1932. This time interval was 12 years and 10 months. The market could gather no lasting upward movement within these nearly thirteen years. The first major price decline was from the top in 2/1920 to the bottom in 10/1923. During these forty-four months, prices dropped 53% from \$4.05 per bushel to \$1.89.

The second 13-year decline was from the major top in 1/1948 to the low in 10/1960. This decline lasted 12 years and 9 months, only one month less than the 2/1920 - 12/1932 decline. The first big drop during this decline was from the top in 1/1948 to the bottom in 11/1949 when prices again dropped 53% from \$4.11 to \$1.95. Notice that the duration of this decline was twenty-two months, or one-half of the first decline from the 1920 top. Both the decline from the 1920 top and from the 1948 top equalled \$2.16, which is exactly one and one-half squares of twelve. That is, both price drops equalled:

$$144 \times 1.5 = 216 \text{ cents per bushel.}$$

This value of \$2.16 is 3/5 of the total \$3.60 price decline that occurred from 2/1920 to 12/1932. Three to five is the ratio of the musical sixth and is the same that

⁴³ Wheat traders will be happy to know that the 13-year cycle is also very strong in that market. W.D. Gann talked about this cycle with reference to wheat and historical records show that it was strong for at least a century before 1920, which is the first major top associated with the soybean data.

CHART XVI.B

13-YEAR DURATION OF BEAR MARKETS

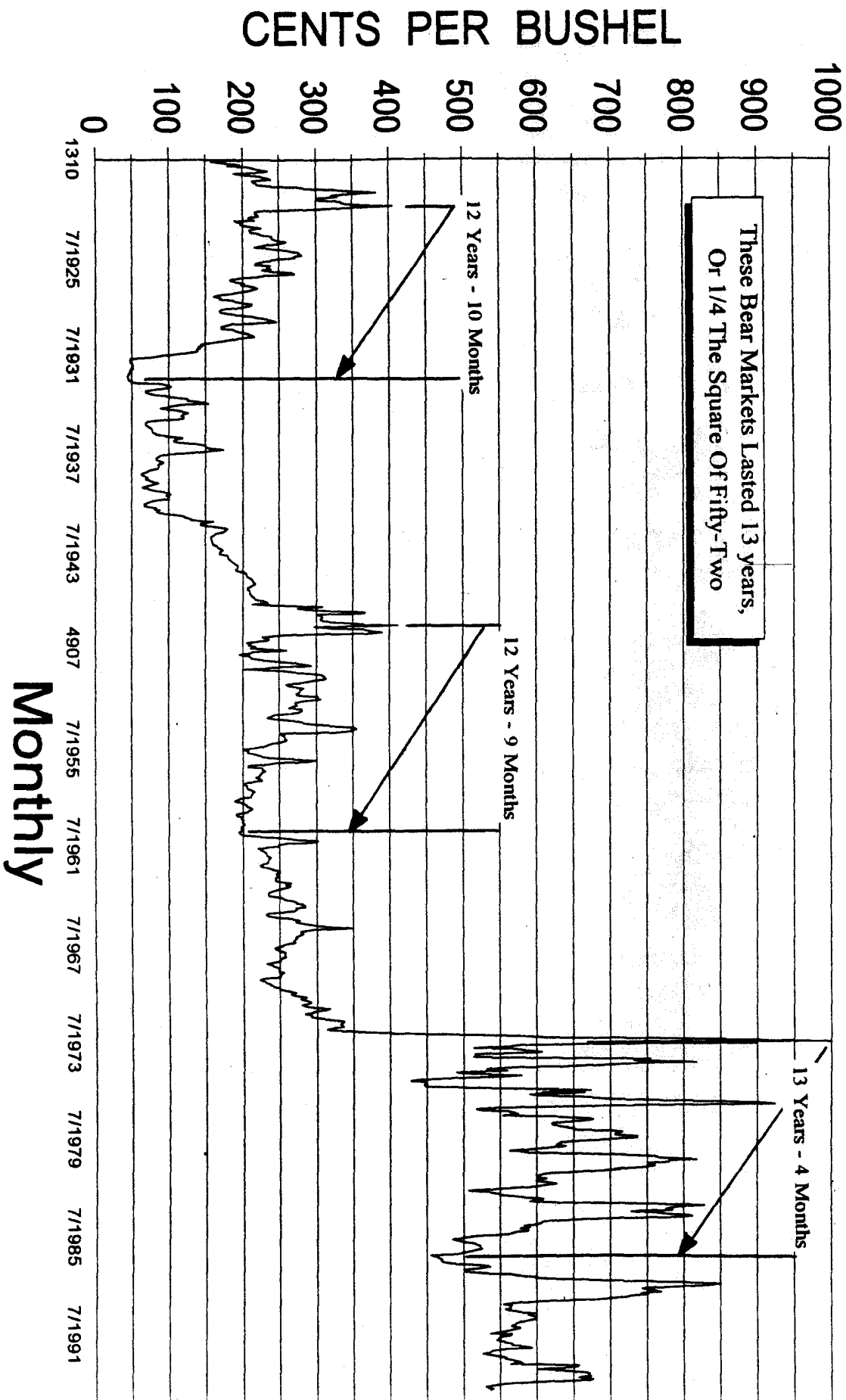

was found between the first PTV™ decline in the 1977 growth spiral and the square of twelve.⁴⁴ Table 14.4 showed that this decline equalled 86.3, which is three-fifths the first square of twelve. In other words, the declines during these two different growth spirals were proportional as follows:

$$\frac{\text{first decline after 2/1920 top}}{\text{total amount of 13-year decline}} = \frac{\text{first decline in 1977 spiral} = (86.3)}{\text{first square of twelve} = (144)}$$

Or, with the numbers for these declines inserted into the above equation,

$$\frac{216 \text{ cents}}{361 \text{ cents}} = \frac{86.3}{144} = \frac{3}{5}$$

The third 13-year decline has happened more recently and is probably well-remembered by most traders reading this material. That bear market lasted from the all-time high of \$10.00 in 6/1973 to the major bottom of \$4.55 in 10/1986, a decline of 54%. This bear market lasted 13 years and 4 months. The first major decline after the 6/1973 top was \$5.72 from \$10.00 to the long-term support line at \$4.28 in 12/1975.⁴⁵ This price drop was the fourth square of twelve and equalled a 57% retracement of the value reached at the 1973 top. Again, this decline followed the same ratio of those preceding it, being 3/5 of the total advance from the low at the bottom of the 13-year cycle in 12/1932.

$$\frac{\text{first decline after 6/1973 top}}{\text{total rally from 12/1932 low}} = \frac{1000 - 428 = 572}{1000 - 44 = 956} = \frac{3}{5}$$

Although each of the three major bear markets that were described above lasted very close to thirteen years, one of the bull markets between them was not of such a clearly fixed duration. This can be seen on Chart XVI.C where the two 13-year bull cycles that have completed since 12/1932, and the partial cycle that is currently unfolding, are shown.

The cycle from the bottom in 12/1932 to the top in 1/1948 lasted over fifteen years. This cycle lasted more than the thirteen years of its counterparts because of the

⁴⁴ The ratios of the musical scale are shown in Table 6.1 in *Four-Dimensional Stock Market Structures And Cycles*. The "sixth" is the sixth tone from the fundamental. Notice the middle column of Table 6.1, which shows how the tones progress from the fundamental to the second, third, etc.

⁴⁵ This is the resistance/support line described in Lesson XIII that stopped the advances into the 1920 and 1948 tops.

CHART XVI.C

BULL MARKETS BETWEEN 13-YEAR BEAR

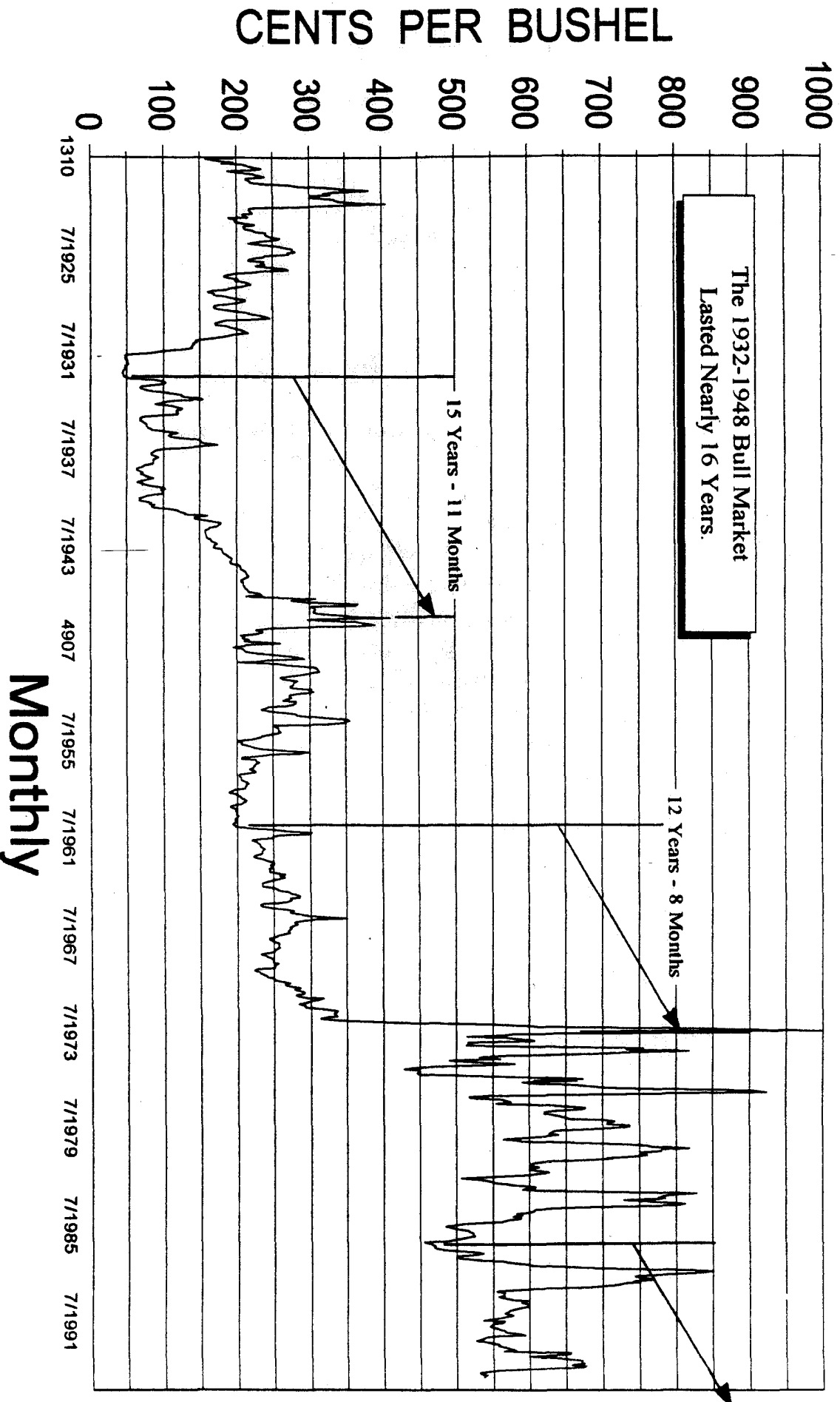

elliptical nature of the underlying planetary cycle, which will be explained in the next section.

The cycle that is currently unfolding began in October, 1986, implying that the 13-year interval will be complete in 1999. This is where the value of knowing the underlying planetary correlation is helpful in more closely identifying how long this interval will last because as the next section will show, this interval will more closely resemble the 1932 to 1948 cycle in duration.

URANUS TRINE IS CORRELATED WITH THE 13-YEAR INTERVAL

To verify the correlation between the 13-year interval and the Uranus cycle it is simply a matter of noting its position at the date the interval began and when it ended, as shown in Table 16.1. The final column of this table clearly shows the sixty-degree movements of Uranus during this 13-year interval.

During the time period from 1918 to 1920 soybeans developed a multiple top. It has already been explained that data was only recorded for a few months out of the year during this time. Fragmented data makes it difficult to correlate planetary cycles with turning points because price data is not available on the date the cycle arrived.

The Uranus trine coincided with the top in 2/1918 when it was at 23° Aquarius, which is 59° from the 12/1932 low. This explains the first row in Table 16.1 that shows the interval from the 1920 top to the 1932 bottom as only 51°.

Table 16.1
Uranus Trine And The 13-Year Interval
(See Charts XVI.B AND XVI.C)

Beginning Date Of 13-Year Interval	Location Of Uranus At Beginning Of 13-Year Interval	Ending Date Of 13-Year Interval	Location Of Uranus At End Of 13-Year Interval	Change In Position
2/1920	2° Pisces	12/1932	22° Aries	51°
12/1932	22° Aries	1/1948	25° Gemini	63°
1/1948	25° Gemini	10/1960	22° Leo	55°
10/1960	22° Leo	6/1973	22° Libra	60°
6/1973	22° Libra	10/1986	22° Sagittarius	60°

It has previously been explained that the Uranus trine will arrive in the year 2001 and not in 1999. This means that the interval from the 1986 bottom will more closely resemble the 15-year cycle from 1932 to 1948. Analysts who apply a static cycle analysis will be surprised when their 13-year interval is actually 15 years.

It must be noted that thirteen years after the 1932 bottom prices were dramatically increasing into the 1948 top.

APPENDIX A

DATA SET CHOSEN FOR THIS ANALYSIS

This appendix appeared in *Square Of Twelve* and was included here because this book may be read many years from now when the first two books can not be found and therefore, it is necessary to make sure that the explanation of the data set used in the analysis is in each book.

The monthly data used throughout this analysis was recorded by the United States Department of Agriculture (USDA) and reported in the "Situation and Outlook Report". These records were first compiled in October, 1913.⁴⁶

This data was compiled by the "National Agricultural Statistical Service" and is the monthly average of prices paid directly to farmers at a variety of grain elevators throughout the United States (eighteen states were surveyed in October, 1994). No distinction was made as to grade when recording these prices. In other words, this data set represents the monthly average paid directly to farmers throughout the United States for all grades of soybeans.

The USDA reported this data on the fifteenth of every month. Therefore, when weekly time components are needed for PTVTM calculation, the number of weeks between the months reported by the USDA are used.

This particular data set was chosen for analysis because it represents this market in its most elemental form, i.e., a broad-based average of prices paid directly to the producer of the product, which is the first sale associated with the product. In contrast, "cash" prices printed in the Wall Street Journal is number 1 yellow and is recorded at Decatur, Illinois⁴⁷. These prices are consistently higher than those recorded at remote grain elevators because they factor in a variety of elements that distort the original price paid to the farmer, such as transportation costs and the resale of the product after being previously purchased from the farmer. Therefore, when this analysis refers to monthly or weekly data, it is the cash price paid to the farmer at grain elevators and NOT the cash prices recorded at the central collection point in Illinois.

However, because daily data was not recorded at these grain elevators, when daily data is used in this analysis it will be that which was recorded at Decatur,

⁴⁶ It is very important to note that the records kept between 1913 and 1923 only included the five months between October and February. It was not until 1924 that data was recorded throughout the year. During these seven months when data was not recorded it is unknown what the prices actually were. Since the charts in this work are for trading months, there is no gap shown when data was not recorded.

⁴⁷ Decatur is located in central Illinois and is a major collection point for soybeans and other commodities, which are originally sold at grain elevators throughout the United States.

Illinois. The time period after 1973 uses this daily data for analysis because the market changed to a higher energy level at that time and the movements became much sharper. Therefore, to achieve the balance between price and time (45° angle) daily time components for PTV™ calculations must be used.

Chart A.1 compares the data recorded by the USDA with the monthly close recorded at Decatur, Illinois. Although the prices of these two graphs are different, their form and turning points coincide. Therefore, if an analyst is able to project a turning point using the prices recorded by the USDA he can also project turning points for the "cash" prices paid at Decatur, Illinois.

It is understood that the majority of readers of this material approach markets from the speculative side and are ultimately interested in futures contracts. Each of these contracts have a unique personality, which may differ from that of the cash values. Again, the advise of W.D. Gann is applicable when he wrote in his *Master Course For Commodities*, " ... use cash prices to get future cycles."⁴⁸ A mastery of the basic (prices paid directly to the farmer) is necessary before advancing to financial market derivatives, such as futures contracts.

⁴⁸ W.D. Gann used the same monthly USDA data set used in this analysis for his time cycle work, which extended from 1913 to his death in 1955. Therefore, when he identified the square of twelve he was looking at the same data set used here. This can be verified by reading his book *How To Make Profits In Commodities*, specifically the soybean section, and noting the data contained within the tables.

CHART A.1

COMPARISON OF USDA & DECATUR DATA

BOTH GRAPHS USE SAME PRICE AXIS

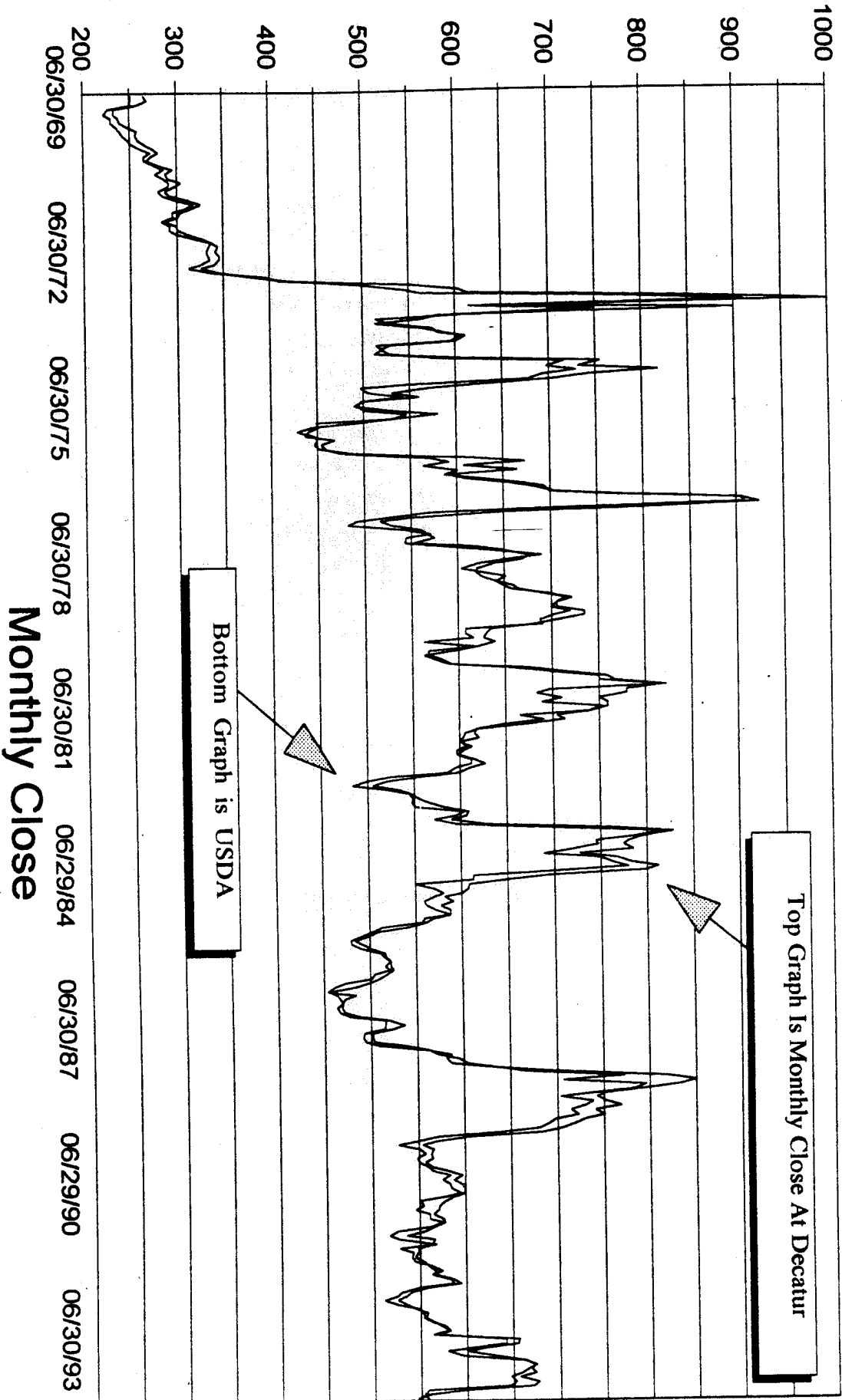

APPENDIX B

DEFINITION OF THE PRICE-TIME RADIUS VECTOR™

The PTV™ is an application of the Pythagorean theorem taught in high school geometry classes, which states that the sum of the squares of the sides of a right triangle is equal to the square of the hypotenuse. In this case, the sides of the right triangle are time and price and the hypotenuse is the PTV™.

One of the many significant insights gained when this technique is applied to price and time analysis is that it defines a single value achieved when price squares with time.³¹

This is shown below where the two sides of the triangle, which are price and time, are at right angles to each other. Note that this does not mean that the PTV™ is only applicable when price and time are on the forty-five degree angle. Rather, it means that the vector measuring the direct distance between two points of force in price-time is determined by placing price and time at right angles to each other.

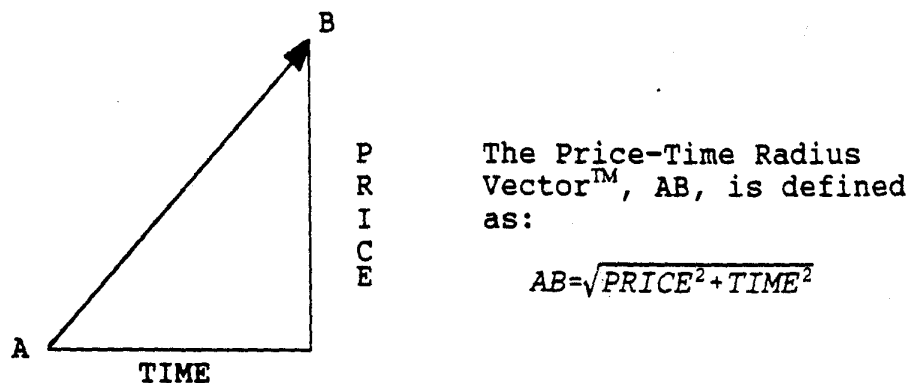

Figure B.1
Definition Of The Price-Time Radius Vector™ (PTV™)

³¹ This should not be confused with price balancing with time, which occurs on a two-dimensional chart on the 45° angle.

APPENDIX C

CURRENT STOCK MARKET GROWTH SPIRAL AND CYCLE UPDATE

The dominant cycles in the Dow Jones Industrial Averages (DJIA) were outlined for the public for the first time in October, 1993 with the release of *Four-Dimensional Stock Market Structures And Cycles*. That work closely studied each cycle and proved their validity by incorporating them into a five-year model that accurately timed every major turning point from the bottom in 1982 to the crash of 1987. The resolution of this model, made in February, 1984, was within two trading days for every turning point, including the crash.

This appendix shows that readers of *Four-Dimensional Stock Market Structures And Cycles*, who did their homework, should have easily predicted every movement since that publication date.

The specific cycles referenced in this appendix are not named because this material is intended as an update for those who have already received *Four-Dimensional Stock Market Structures And Cycles*. It would be unfair to those who purchased that material to release these cycles to those who do not have it. Therefore, the charts in *Four-Dimensional Stock Market Structures And Cycles* describing the cycles are referenced instead of naming the underlying cycle. This will allow those with *Four-Dimensional Stock Market Structures And Cycles* to easily identify the specific cycle that is being updated.

In addition to the stock market cycles, this appendix shows the contracting growth spiral that has been unfolding in the stock market since the crash of 1987. Although this spiral has been trending upward in price, the vectorial magnitudes of its constituent sections have been contracting by a factor of the square root of two. That is, the vectorial magnitudes of the advances and those of the declines have been getting progressively smaller by the factor of 1.414.

STOCK MARKET CYCLES

Charts VIII.P, VIII.S, and VIII.T in *Four-Dimensional Stock Market Structures And Cycles* showed two of the major cycles affecting the DJIA.⁵⁰ The location of these cycles were shown from the top in 10/1987 to the top in 6/1992 with the larger

⁵⁰ It is recommended the reader review those two charts and their descriptions on pages 160-163 at this time.

CHART C.1

DJIA CYCLE UPDATE

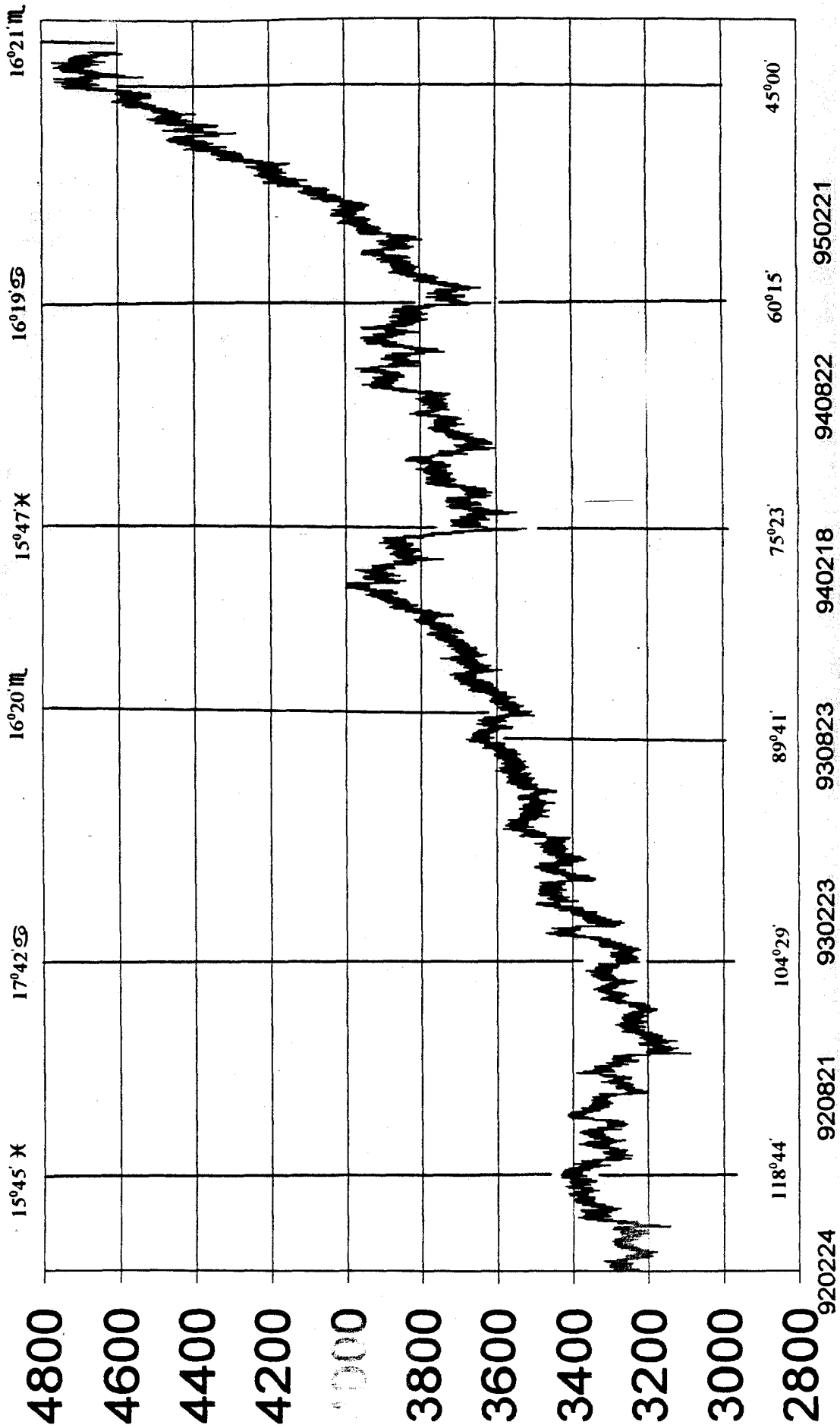

Daily

cycle going back to 1980. Chart C.1 updates these two cycles to the date of this writing in August, 1995. The lines drawn below the graph on this chart show the 15° axis of the longer-term cycle and the lines drawn above the graph show the trine of the correspondingly synchronized shorter-term cycle. These two cycles are the same as those shown on Charts VIII.S and VIII.T in *Four-Dimensional Stock Market Structures And Cycles*. Notice how these cycles defined the bottoms in 1/21/1993, 9/24/1993, the double bottom in 4/4/1994 and 4/20/1994, and most recently in 11/23/1994. Rather than provide a written description of each of these declines, it is recommended that the reader carefully study this chart to see how precisely the declines coincided with the cycles.

If the analyst had worked enough to be aware of the location of this single principle of cycle synchronicity his work would have been greatly rewarded. Those traders who had *Four-Dimensional Stock Market Structures And Cycles* and were caught unprepared for those declines should ask themselves why they missed the opportunities they provided. Readers who received the material in October, 1993 and missed the January, 1994 top simply did not do their homework.

In addition to the cycles shown on Charts VIII.S and VIII.T, the top in January, 1994 was exactly 120° from the top in October, 1987 of the cycle shown on Chart VIII.O. This cycle also defined the top in 9/19/1994 when at 109° it was 45° from the bottom in 12/1991, as shown on Chart VIII.O. Remember, it is 45° in this cycle that defines each of the solid vertical lines shown on Chart VIII.O.

To determine when the next cycle shown on Chart VIII.I is due, the analyst should follow the technique described on page 138 in *Four-Dimensional Stock Market Structures And Cycles* and measure 15 degrees from the 1/1994 top. Similarly, find the points that are 60 degrees from the 8/1987 top, 45 degrees from the 10/1989 top, and 30 degrees from the 12/1991 bottom.

When the date is found that coincides with this cycle, find the location of the cycle shown on Chart C.1 to see if there are two or more cycles due at that time. It is when all the cycles arrive at an axis at the same time that turning points like 8/1987 and 7/1990 occur.

CURRENT STOCK MARKET GROWTH SPIRAL

The PTVs™ shown on Chart C.2 of the Dow Jones Industrial Average identify the root two spacial relationships between the four largest counter-trend reactions within the contracting growth spiral that occurred between 8/1987 and 11/1994. The data for the PTVs™ shown on this chart are contained in Table C.1.

WWW.FOREX-WAREZ.COM
ANDREYBBRY@GMAIL.COM SKYPE: ANDREYBBRY

CHART C.2

ROOT TWO VECTORIAL DECOMPOSITION

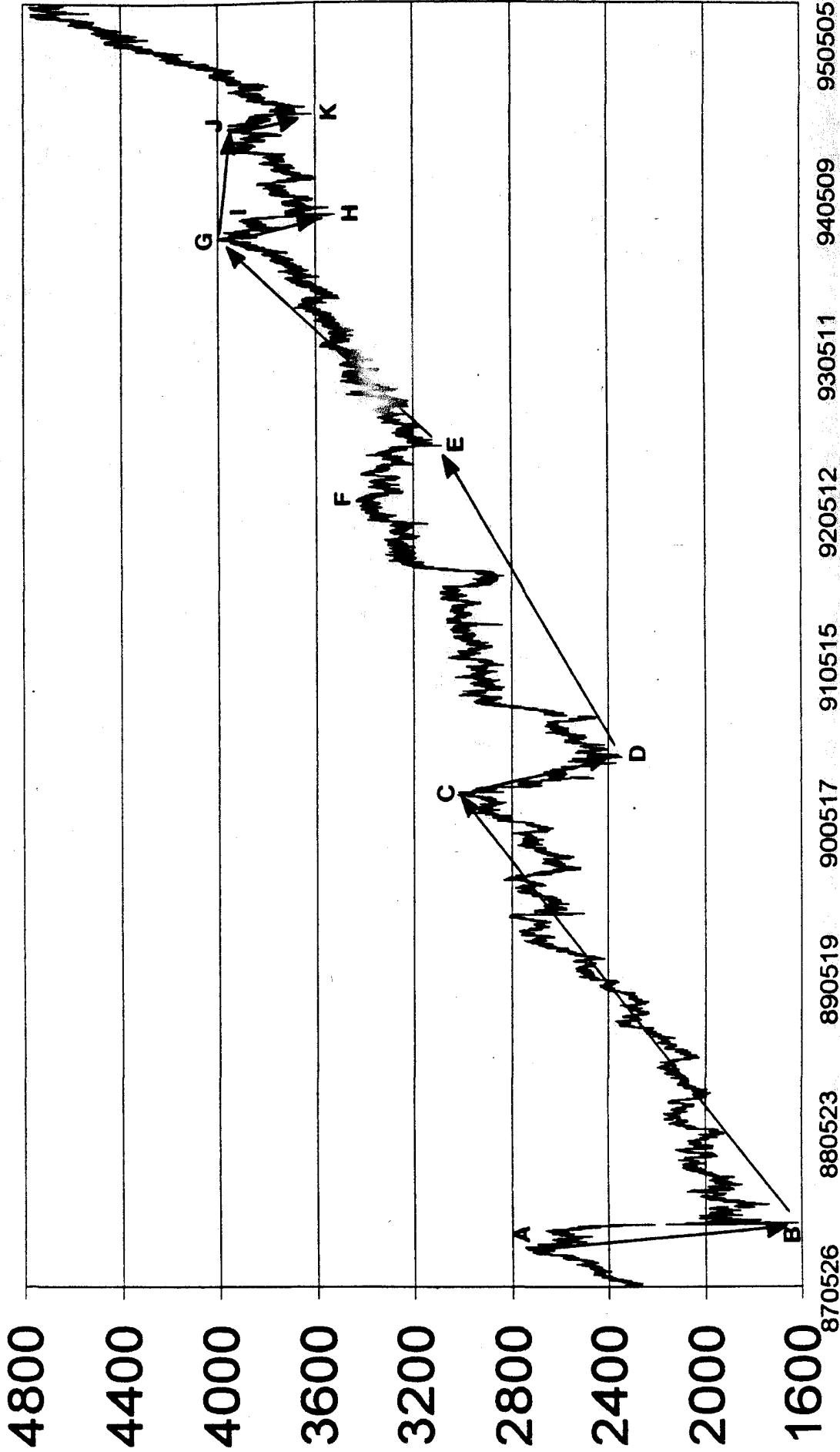

Daily

Table C.1
PTV™ Calculations for Chart C.2
Dow Jones Industrial Average (DJIA) 10/1987 - 1/1994

Price-Time Radius Vector	Date of High	PTV™ Price High	Date & Time of Low	PTV™ Price Low	Time Change (in hours)	Price Change Points	Vector Value (PTV™)
AB	8/25/1987	2746.65	10/20/1987	1616.21	253.5 (39 days)	1130.44	1158.5
BC	7/20/1990	3019.31	10/20/1987	1616.21	4511 (694 days)	1403.10	4724.2
CD	7/17/1990	3024.26	10/11/1990	2344.31	403 (62 days)	679.95	790.4
DE	10/5/1992	3087.41	10/11/1990	2344.31	3256.5 (501 days)	743.10	3340.2
EF	6/2/1992	3435.24	10/5/1992	3087.41	565.5 (87 days)	347.83	663.9
EG	1/31/1994	4002.84	10/5/1992	3087.41	2177.5 (335 days)	915.43	2362.1
GH	1/31/1994	4002.84	4/4/1994	3520.80	279.5 (43 days)	482.04	557.2
HI	3/18/1994	3911.78	4/4/1994	3520.80	64 (10 days)	390.98	396.2
GJ	1/31/1994	4002.84	10/19/1994	3958.25	1176.5 (181 days)	44.59	1177.3
JK	10/19/1994	3944.12	11/23/1994	3612.05	161.5 (25 days)	346.20	382.0

These reactions were:

- AB - 8/1987-10/1987
- CD - 7/1990-10/1990
- GH - 1/1994-4/1994
- IH - 3/1994-4/1994
- JK - 10/1994-11/1994

The magnitudes of the PTVs™ defining these reactions were in root two ratios. That is,

$$\sqrt{2} = \frac{AB}{CD} = \frac{CD}{GH} = \frac{GH}{IH} \cong \frac{GH}{JK}$$

Or, with the numbers inserted,

$$\sqrt{2} = \frac{1158}{790} = \frac{790}{557} = \frac{557}{395} \cong \frac{557}{382}$$

Not only were the magnitudes of these reactions in root two ratios, but also, the vectorial spacing **BETWEEN** them was root two. That is,

$$\sqrt{2} = \frac{BC}{DE} = \frac{DE}{EG}$$

Or, with the numbers inserted,

$$\sqrt{2} = \frac{4724}{3340} = \frac{3340}{2362}$$

Similarly,

$$\frac{BC}{EG} = \frac{4724}{2362} = 2$$

And,

$$\frac{EG}{GJ} = \frac{2362}{1177} = 2$$

Most of these ratios worked out **EXACTLY**. The EF ellipse is the arithmetic mean (average) between the CD and GH PTVs™. That is,

$$\frac{CD + GH}{2} = \frac{790 + 557}{2} = 673$$

Notice that GJ, from the top in 1/1994 to the top in 10/1994, pointed nearly parallel to the time axis. This is how the PTV™ relates to the square. When it points straight down the price or time axis its magnitude defines a side of the square. The

magnitude of GJ was 1177.3, which is EG divided by two. A closer look at Table C.1 shows that EG did not have either a price or time component that was a multiple of 1177, again proving the value of the PTV™.

Chart XIII.C showed that as the tunnel containing this action moved away from the observer from left to right on the page, its width narrowed. This is what defines the tunnel as a contracting growth spiral. Each of the major declines in this tunnel are actually slices taken out of it, explaining their elliptical appearance.

The crash in 1987 represented the transition point from the expanding and the contracting phase of the torus, as shown in Figure 13.8. Between 1982 and 1987 the tunnel was expanding, as the action moved from the left side of the torus to the middle. The point in 1987 was similar to the point in 1974 in the 1966-1982 growth spiral. After the center was passed, the containment perimeter of the growth spiral was narrowing, resulting in the vectorial contraction.

This type of activity is very typical of all markets. There is a period of expansion followed by a period of contraction. These sections of alternating expansion and contraction do not necessarily mean that prices will trend up and then down. Rather, it means that the vectorial swings will get larger as the center of the torus is approached and then progressively smaller when this center is passed. Since 1982, the stock market has been on an upward trend, just as it was during the 1949 to 1966 square. However, during the 1966 to 1982 square, there was no dominant trend, making it easier to visually identify the expansion and contraction of the torus.

Do not confuse the phases of expansion and contraction explained above with bull and bear markets. A period of vectorial expansion has both bull and bear movements, as does the period of contraction.

The root two vectorial decomposition described above is identical to the system of contraction described on page 46 of *Four-Dimensional Stock Market Structures And Cycles* and shown in Figure 4.3. The only difference is that Figure 4.3 is a front view of the tunnel and Chart C.2 is a side view.

DOMINANT PTVs™ ARE RELATED TO A FUNDAMENTAL UNIT

Notice that the PTVs™ shown on Chart C.2 are integrally related to 236, which was the elemental unit of measurement used in Lesson I of *Four-Dimensional Stock Market Structures And Cycles*. This should clearly define how all these PTV™ lengths are interrelated. For example,

$$\frac{4724}{236} = 20$$

$$\frac{2362}{236} = 10$$

$$\frac{1177}{236} = 5$$

$$\frac{790}{236} = 10/3$$

$$\frac{395}{236} = 5/3$$

DOMINANT PTV™ MAGNITUDES ALSO SHOW UP IN PRICE AND TIME

The most recent declines in the DJIA have had the vectorial magnitudes of 395. It is important to be aware that the value of 395 not only shows up in price-time, but also, in price and time, especially when a longer time frame is studied. The reasons for this have been explained many times in previous writings. Briefly, this happens when the PTV™ is pointing parallel to either the price or time axes, defining the limits of the square.

Several examples of this square can be seen on Chart C.3. The price change from the low of 770 in 8/1982 to the high of 2747 in 8/1987 was 1975 points, which is 395 multiplied by 5. That is,

$$2746 - 770 = 1975 \text{ points} = 395 \times 5$$

Similarly, the top at 2747 in 8/1987 was six squares of 395 from the high of 386 in 9/1929. That is,

$$2746 - 386 = 2360 \text{ points} = 395 \times 6$$

The value shown above of 2360 points, which is the price change from the top in 9/1929 to the top in 8/1987, is the same as the PTV™ labeled EG on Chart C.2.

In 9/1929 the market topped at 386, beginning the Great Depression. This value is one-half of the low at 772 in 8/1982, exactly 2/3 of the low in 12/1974, and very close to the 395 used above. This number is exactly one third of the vectorial decline during the crash of 1987.

CHART C.3 395 IN DJIA

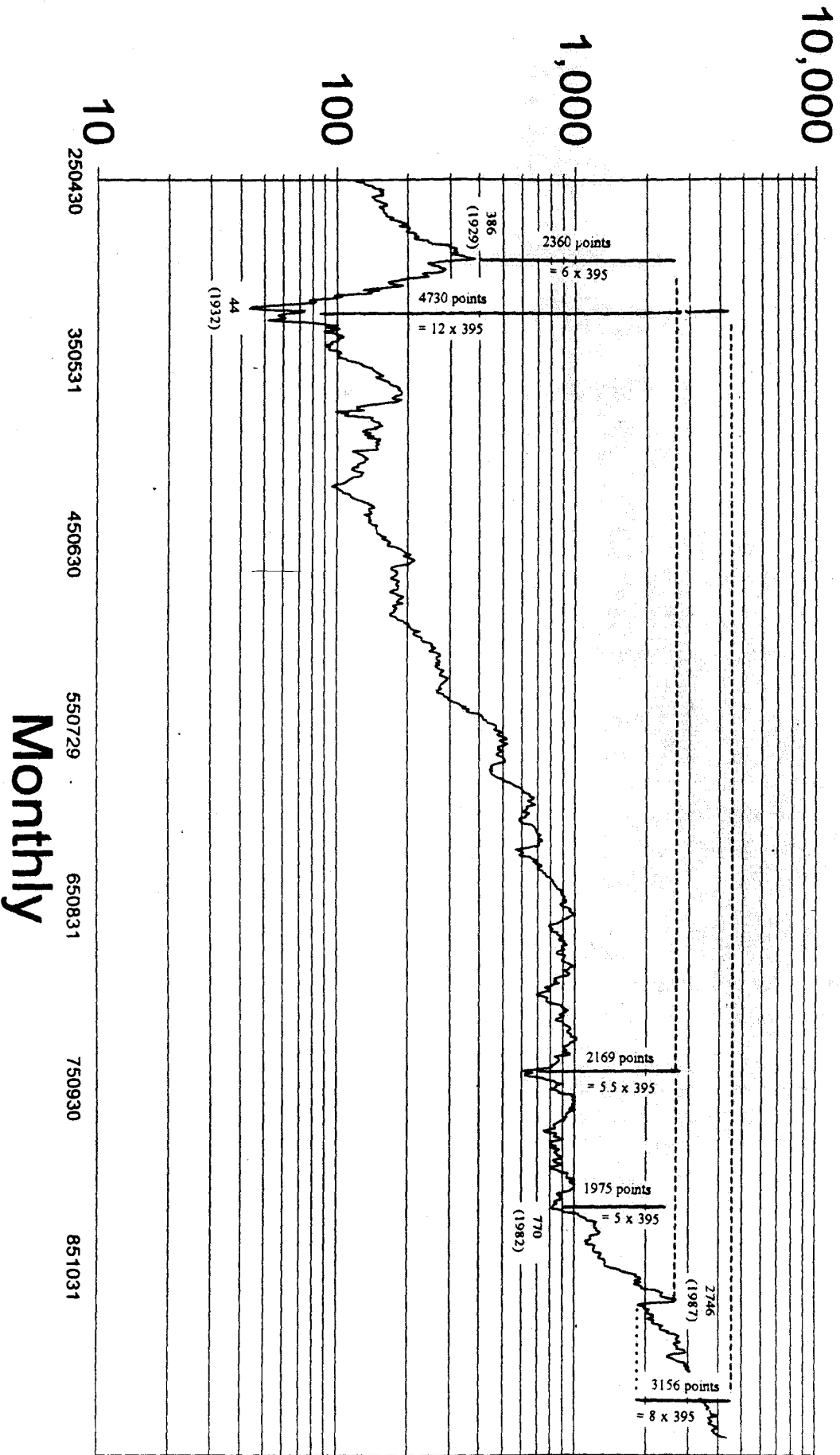

That is,

$$1158 / 386 = 3$$

Most recently, the DJIA ran into resistance at 4772 on August 2, 1995. This value is 8 squares of 395 from the crash low of 1616 in 10/1987 and 12 squares of 395 from the all-time low of 42 in 1932. That is,

$$4772 - 1616 = 3156 \text{ points} = 395 \times 8$$

And,

$$4772 - 42 = 4730 \text{ points} = 395 \times 12$$

Now, it can be seen how the Fibonacci relationship works into price analysis. The price move from 10/1987 to 8/1995 was, approximately, 1.62 times the move from 8/1982 to 8/1987 because one is eight squares of 395 and the other is five. That is,

$$\frac{4772 - 1616}{2746 - 770} = \frac{3156 \text{ points}}{1975 \text{ points}} = \frac{8 \times 395}{5 \times 395} = 1.62$$

Many market analysts will no-doubt recognize the Fibonacci relationship between the price changes mentioned above. However, none will understand why it has arisen and few, if any, will figure out that these movements are in fact integral multiples of the square of 395.

There are many more Fibonacci relationships in the long-term price changes of the DJIA. The reader is encouraged to take the key turning points and find these relationships and how they reduce to the square of 395.

In the dimension of time, 395 is related to the Mercury cycle. Because there are 6.5 trading hours per day, there are 395 trading hours in 60 trading days, which is the complete twelve-week Mercury cycle.

This relationship shows how price and time are intimately connected. Once a value is found to consistently repeat in one dimension, such as price, it will also be found in the other, such as time.

And this is not only limited to price and time, but the recurring value will also be found in price-time because this establishes the rate of vibration of the particular market. The value of 395 was shown above to be clearly present in price; in time; and, as shown in Table C.1, in price-time.

This relationship is not limited to 395. For example, the value of 2360, which is the sixth square of 395, was shown to measure the price change from the 1929 top

to the top before the crash in 1987. This value was also equal to FG in Table C.1. In the dimension of time, this value is six Mercury cycles. Other planetary correlations can be found by studying Figure 6.3 in *Four-Dimensional Stock Market Structures And Cycles*.

THE PTV™ ESTABLISHES THE RATE OF VIBRATION

Hopefully, the above description has been successful in showing how the PTV™ is used to quantify the rate of vibration of a particular market. Although traders such as W.D. Gann used numbered squares to define the price and time components of these vibrations, the PTV™ goes beyond that analysis and locates points of force in price-time.

APPENDIX D

MUSICAL FIFTH IN PRICE-TIME

Initially, it may seem curious that an appendix on the musical fifth is included in a book on market dynamics. Understanding the musical scales is important to financial market timing because music is geometry in motion, and the orientation of points of force in price-time can be located and predicted after mastery of the underlying geometry.

The similarity between geometry and music has been known and put into practice for centuries. In fact, many of the ancient Greek architects restricted the dimensions of the floor plans of their buildings to the ratios found in the musical scale, which can be derived from a simple geometric series based on the musical fifth.

The diatonic musical scale, including the importance of the musical fifth, was described on pages 98-100 in *Four-Dimensional Stock Market Structures And Cycles*.⁵¹ Therefore, the methodology used to develop this musical scale will not be repeated here in order to avoid unnecessary redundancy in this series of books.

All the ratios defining the tones in the diatonic musical scale are found in the spatial orientation of points of force in price-time because these ratios are an inherent consequence of the geometric and arithmetic proportions within growth spirals. However, when spirals in nature, ranging from the horns of bulls to galactic spirals, are carefully studied the one musical ratio that is found to recur most often is the fifth, or 3:2. This ratio is the basis for the Pythagorean musical scale where a sequence of fifths are taken from a fundamental tone and all reduced to a single octave by removing the value of unity.

This appendix shows many examples of the musical fifth throughout the entire history of the soybean market and in a section of the Dow Jones Industrial Average, with which the reader should now be very familiar, the 1966-1982 square.

First, it will be shown that the magnitudes of individual PTVsTM in the 1913-1969 growth spiral decomposed in the ratio of the musical fifth, as this spiral contracted toward its 1969 terminus.

Second, the triangles formed by the major points of force within this same spiral will be shown to also contract in the ratio 3:2.

⁵¹ Those pages in *Four-Dimensional Stock Market Structures And Cycles* should be carefully reviewed because, as this appendix shows, the vectorial harmonics in many financial market growth spirals subdivide in this important ratio of three to two (3:2) at the appropriate locations within the spiral.

Finally, examples of this principle will be shown in an expanding growth spiral in the Dow Jones Industrial Average, where the combination of PTVs™ increased in this same ratio during the 1966-1982 square.

Chart XI.B in *Square Of Twelve* showed the PTVs™ in the cash soybean market within the 1913-1969 contracting growth spiral⁵². That chart is reproduced in this appendix as Chart D.1 and the related data are contained in Table D.1.

Table D.1
PTV™ Calculations For Chart D.1 (1913 - 1969)
(Data Recorded By USDA)

Price-Time Radius Vector™	Date of Low	PTV™ Price Low	Date of High	PTV™ Price High	Time Change in Weeks	Price Change in Cents	Vector Value (PTV™)
AB	11/1913	157	2/1920	405	325 Weeks	248	408.8
BC	2/1932	48	2/1920	405	624 Weeks	357	718.9
BD	12/1932	44	2/1920	405	665 Weeks	361	756.7
BE	2/1920	405	1/1948	411	1452 Weeks	6	1452.0
BF	11/1958	189	2/1920	405	2015 Weeks	216	2026.5
BI	10/1969	223	2/1920	405	2583 Weeks	182	2589.4
BJ	10/1961	194	2/1920	405	2167 Weeks	211	2177.2
CG	2/1932	44	9/1959	190	1434 Weeks	146	1441.4
DE	12/1932	44	1/1948	411	784 Weeks	367	865.6
DI	12/1932	44	10/1969	223	1916 Weeks	179	1924.3
EG	9/1959	190	1/1948	411	607 Weeks	221	646.0
EH	8/1966	349	1/1948	411	966 Weeks	62	968.0
FH	11/1958	189	8/1966	349	403 Weeks	160	433.6
FI	11/1958	189	10/1969	223	568 Weeks	34	569.0
HI	10/1969	223	8/1966	349	165 Weeks	126	207.6

⁵² These PTVs™ were each explained in detail in *Square Of Twelve*, and that information will not be repeated here.

CHART D.1 MUSICAL FIFTH IN 1913 - 1969 SPIRAL

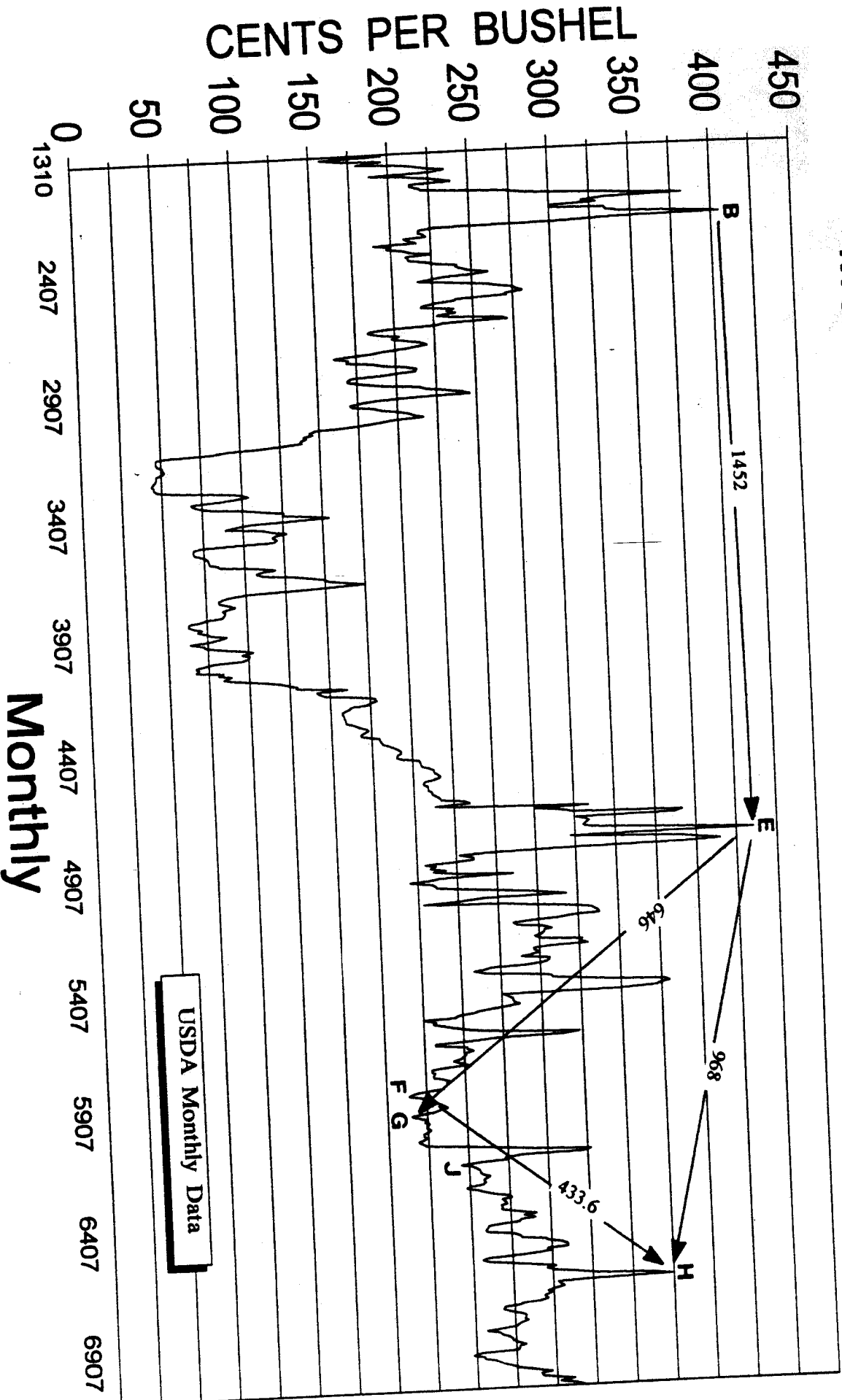

The ratios between the PTVs™ within this contracting growth spiral are shown in Table D.2. Column one contains the two PTVs™ that are being compared and their numerical values are in column two. Column three shows the ratios between the two PTVs™ in column two. Notice that these ratios matched the musical fifth (1.5) to the third decimal point, which is well within the number of significant digits available with this data.

The first PTV™ shown in Table D.2 is BJ, a 41-year vector from 1920 to 1961. BJ is divided by 1.5 to obtain the second entry in this table, BE = 1452. This process is continued using 1.5 as a divisor until each value in Table D.2 is obtained with the final value equal to the second square of twelve, 288. The second square of twelve (288) and the musical fifth were the elemental building blocks upon which all these PTVs™ were defined. In other words,

THE CHANGE IN MAGNITUDES OF THE PTVs™ MEASURING THE PRICE-TIME SPACING WITHIN THIS GROWTH SPIRAL FOLLOW THE SAME RULES AS THE PYTHAGOREAN MUSICAL SCALE.

A sequence of fifths are taken from the fundamental tone and, in the case of the soybean market, the fundamental tone is the square of twelve.

Table D.2
Ratio Of The Musical Fifth In 1913 - 1969 Spiral
Data Recorded By USDA
(See Chart D.1)

PTVs™ In Ratio Of Musical Fifth Ratio	Values Of PTVs™ In Column One	Ratio Between PTVs™ In Column Two
BJ / BE	2177 / 1452	1.499
BE / EH	1452 / 968	1.500
EH / EG	968 / 646	1.498
EG / FH	646 / 433.6	1.490
FH / 288	433.6 / 288	1.506

It is now clear why the value of BE was not a perfect multiple of 144. This PTV™ measured 1452, which is twelve more than the tenth square of twelve, 1440. The value of BE was built upon the sequence of musical fifths taken from the second square of twelve, 288.

Another relation that presents itself when studying the internal workings of growth spirals is how the musical fifth defines the COMBINATION of successive PTVs™. For example, the sum of BD and DE are in the ratio of 3:2 to the sum of EG and FH. That is,

$$BD + DE = (EG + FH) \times 3/2$$

Or, with the numbers inserted,

$$BD + DE = 756.7 + 865.6 = 1622.3$$

And,

$$EG + FH = 646.0 + 433.6 = 1079.6$$

Dividing these two sums,

$$\frac{BD + DE}{EG + FH} = \frac{756.7 + 865.6}{646 + 433.6} = \frac{1622.3}{1079.6} = 1.503$$

And since the two PTVs™, BE and EH, were shown in Table D.2 to be in the ratio of 3:2, this means that the perimeter of the triangle created by the three PTVs™, BD, DE, and BE is 1.5 times the perimeter of the triangle created by the three PTVs™, EG, FH, and EH. That is,

$$(EG + FH + EH) \times 1.5 = BD + DE + BE$$

Or, with the numbers inserted,

$$\frac{646 + 433.6 + 968}{756.7 + 865.6 + 1452} = \frac{2047.6}{3074.3} = 1.501$$

If the reader will take the time to work through the partitioned PTVs™ from the 1977 growth spiral that were identified in the first part of this book, he will find similar recurrences of the musical fifth in that spiral.

CHART D.2

MUSICAL FIFTH IN DJIA

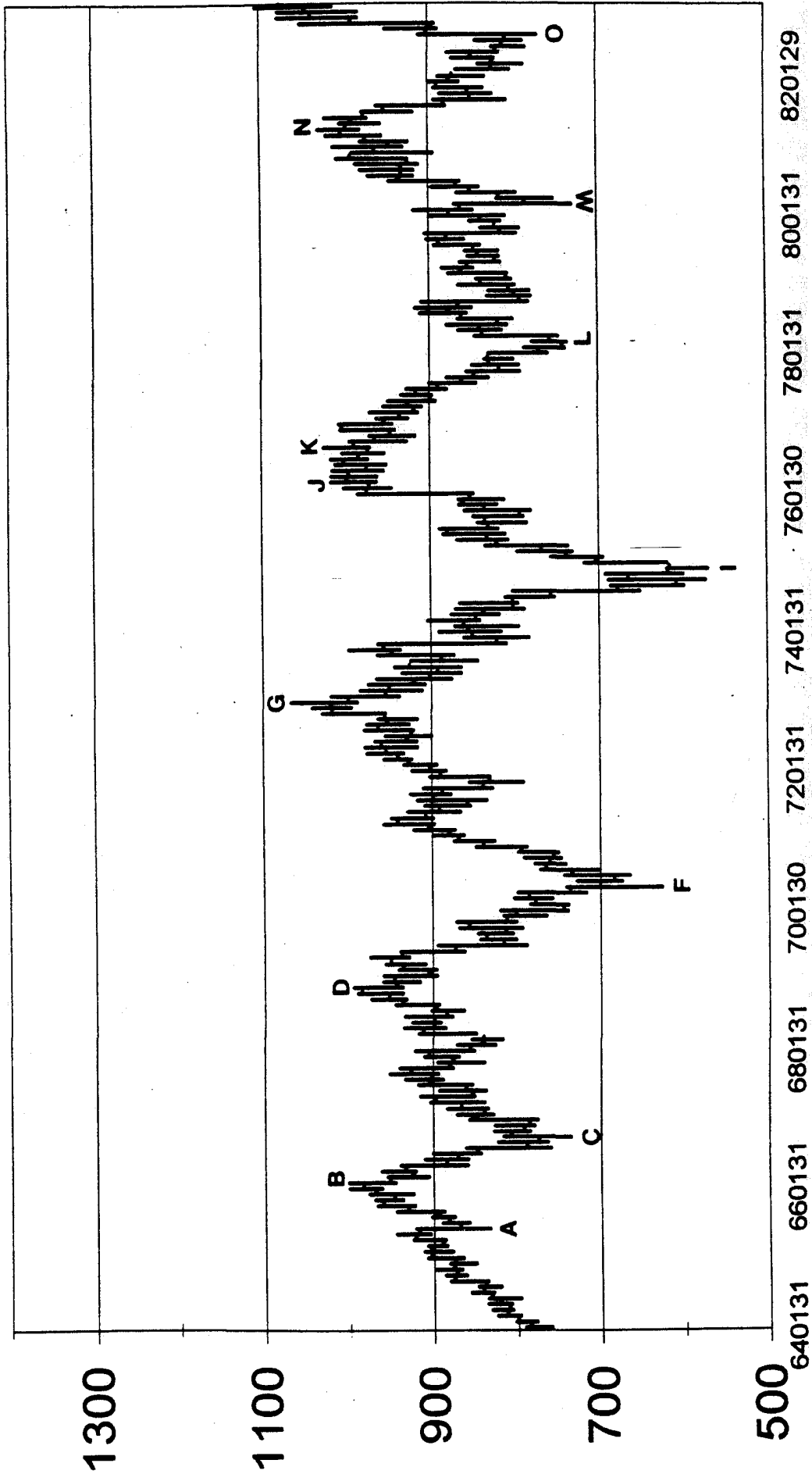

Monthly

MUSICAL FIFTH IN THE DOW JONES INDUSTRIAL AVERAGE

Chart D.2 shows the 1966-1982 square in the Dow Jones Industrial Average (DJIA). The data for the PTVs™ on this chart are contained in Table D.3.

Table D.3
PTV™ Calculations For Chart D.2
Dow Jones Industrial Average (1966 -1982)

Price-Time Radius Vector™	Date of Low	PTV™ Price Low	Date of High	PTV™ Price High	Time Change in Trading Days	Price Change Points	Vector Value (PTV™)
AB	6/29/1965	832.74	2/9/1966	1001.11	142	168.37	220.26
BC	10/10/1966	735.74	2/9/1966	1001.11	168	265.37	321.89
BD	12/2/1968	994.65	2/9/1966	1001.11	684	6.46	684.03
DG	12/2/1968	994.65	1/11/1973	1067.2	1717	72.55	1718.53
CD	10/10/1966	735.74	12/2/1968	994.65	516	258.91	577.31
CE	10/10/1966	735.74	5/14/1969	974.92	624	239.18	668.27
DF	5/26/1970	627.46	12/2/1968	994.65	368	367.19	519.86
DG	12/2/1968	994.92	1/11/1973	1067.2	1033	72.28	1035.53
EF	5/26/1970	627.46	5/14/1969	974.92	260	347.46	433.97
FG	5/26/1970	627.46	1/11/1973	1067.2	665	439.74	797.24
FI	12/9/1974	570.01	5/26/1970	627.46	1147	57.45	1148.44
GH	10/4/1974	573.22	1/11/1973	1067.2	437	493.98	659.53
GI	12/9/1974	570.01	1/11/1973	1067.2	482	497.19	692.48
IJ	12/9/1974	570.01	3/24/1976	1018.03	326	448.02	554.07
IK	12/9/1974	570.01	9/22/1976	1026.26	452	456.25	642.24
IL	12/9/1974	570.01	3/1/1978	736.75	814	166.74	830.90
JL	3/1/1978	736.75	3/24/1976	1018.03	488	281.28	563.26
KL	3/1/1978	736.75	9/22/1976	1026.26	362	289.51	463.53
MN	3/27/1980	729.9	6/15/1981	1023.02	306	293.07	423.71
NO	8/9/1982	769.98	6/15/1981	1023.02	291	253.04	385.63
OP	8/9/1982	769.98	1/10/1984	1295.44	360	525.46	636.95

Many of the PTVTM values in Table D.3 are the same as those from the 1977 growth spiral in the soybean market.⁵³ A few of the common PTVTM values between these two different spirals in two different markets are:

891
693
577
331
1033

Some of the ratios between the PTVsTM in Table D.3 that are in ratio of the musical fifth are tabulated below in Table D.4. It should be noted that there are many more examples of this ratio when the PTVsTM are organized in their appropriate spatial configuration within the growth spiral.

Table D.4
Musical Fifth In The Stock Market
Daily Dow Jones Industrial Average (1966 - 1982)

PTVs TM In The Ratio Of The Musical Fifth	Values Of PTVs TM In Column One	Ratio Between PTVs TM In Column Two
AB / BC	322 / 220	1.464 ⁵⁴
DG / FI	1719 / 1148	1.497
IK / MN	642 / 424	1.514
OP / MN	637 / 424	1.502
DG / GI	1036 / 692	1.497
DG / BD	1035 / 684	1.513
CD / NO	577 / 386	1.495
IL / IJ	831 / 554	1.500

⁵³ The author has commented many times on the similarity between the 1966-1982 DJIA growth spiral and the 1978 soybean spiral. Both markets topped out in the 1000 area and both bottomed near the 500 area. Adding the similarity of PTVTM values between these two spirals should make the reader give this some serious thought.

⁵⁴ The top in 1966, at point B, was very flat. During the time when this top was occurring, prices stayed near the same level for several weeks. For this reason, the value of AB is difficult to pinpoint.

Other than the octave, the analyst will find that the musical fifth is the most common ratio in price-time because it is created by the two simple integers 3 and 2. When a tone is played with its fifth, the result is a sound that is pleasing to the ear, much as the octave.

APPENDIX C

CORRELATION BETWEEN THE DIMENSIONS OF ANCIENT TEMPLES AND THE VECTORIAL EXPANSION OF THE SOYBEAN MARKET

Most people have heard of the Great Egyptian Pyramid at Giza. However, there are literally hundreds of monuments around the world that were built by pre-historic man that do not receive the attention of the great pyramids. For the most part, the builders of these structures are unknown to us.

The architecture of many of these structures show a mathematical understanding that was much more advanced than modern historians believe their builders capable of mastering. This work will show that the dimensions used in the construction of these temples were based on the "square of twelve", which is the elemental building block of the soybean market. These same numbers are found in ancient monuments and temples that were constructed in Egypt, Mexico, Bolivia, Ecuador, and other locations throughout the world at greatly varying times in history.

As with many topics related to market timing, there could be volumes written on the correlation between these monuments and the spatial orientation of price-time. This appendix is only intended as an introduction to this subject and to show that there is a common universal law that not only applies to financial market movements but was also understood by ancient mathematicians when they created their greatest possible achievements.

Some may find it difficult to understand how there could be similarities between two seemingly unrelated topics as ancient temples and soybean growth spirals however, a little more thought will reveal that it is not such an unthinkable prospect. If these ancients had attained an advanced understanding of cosmology, as many believe, it is not hard to believe that they would incorporate that knowledge into their highest of all tributes, those to their gods. Similarly, this series of books has shown these same cosmological influences are manifest in the growth spirals of financial markets. Therefore, it follows that when we are comparing the mathematical dimensions of ancient temples with the spatial orientation of soybean growth spirals we are effectively looking at a common reflection of the same cosmological influences that have apparently been understood since the beginning of civilization.

Whatever conclusion the reader reaches, this material will be presented for his review and he can make his own judgements. The author's objective is to present the evidence and show that the numbers found in ancient temples match those found in the soybean market.

TOWER OF BABEL

Figure E.1 shows the dimensions of the Tower Of Babel. The units used in this measurement are those used by its builders and are called "Sumerian feet", 0.310723 meters. This unit is very close in value to one degree of longitude at the location of its construction divided by 360,000.

As the tower was built from the bottom up, the size of each terrace became progressively smaller. The numbers along the left side of this figure represent the width of each terrace in Sumerian feet.

The base of this tower is the first terrace and measures 288 x 288, a number that should now be quite familiar to those reading this work. Also, the total height of the temple is 288 Sumerian feet, making it fit into a cube with side length of 288. At the top of the tower is the "Temple of Marduk", which is 24 feet tall. This means that the total height of the tower to the base of the temple is 264 feet and the total height to the top of the temple is 288 feet. The two numbers 264 and 288 not only represent the total height of the tower with and without the temple at the top, but also, the size of the first two terraces, which have the dimensions of 264 and 288 feet.

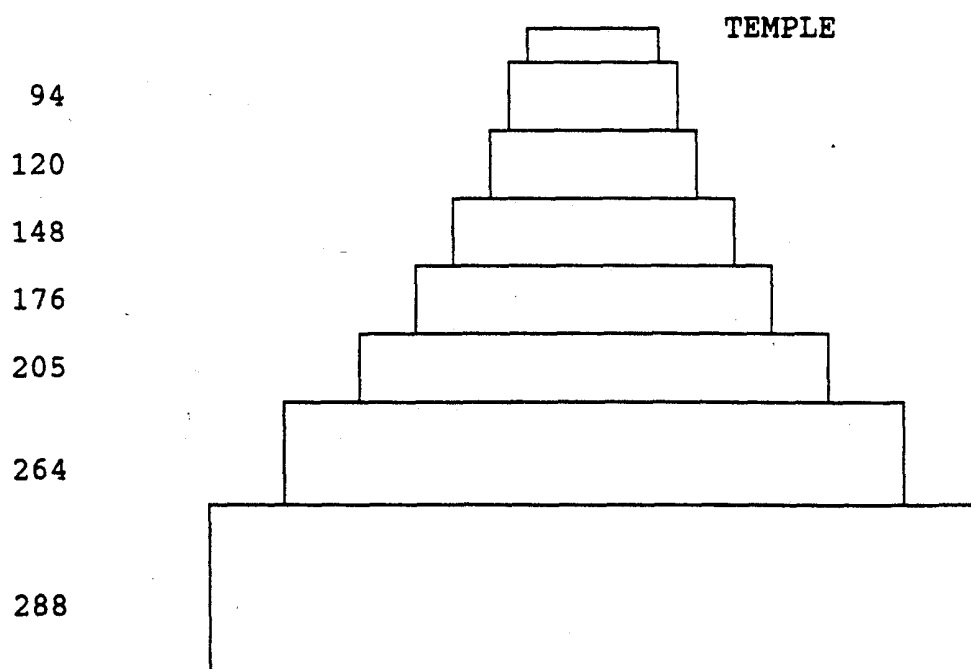

Figure E.1

Dimensions Of The Tower Of Babel In Sumerian Feet And The Square Of Twelve

Similarly, the dimension of the third terrace is 204 Sumerian feet. These numbers are important to soybeans because,

THE NUMBERS IN THE TOWER OF BABEL ARE IDENTICAL TO THOSE DEFINING THE EXPANSION IN THE SOYBEAN MARKET GROWTH SPIRAL.

Chart E.1 shows the growth spiral in the cash soybean market between 1978 and 1992. These are the same PTVs™ shown on Chart XIV.C and contained in Table 14.4. The vectorial expansion of the declines on this chart are identical to the dimensions in the Tower Of Babel. Column two in Table E.1 subtracts each decline in this growth spiral from the decline immediately preceding it and column three shows the corresponding width of the Tower Of Babel.

The following sections will show that these same numbers are found in many ancient temples throughout the world that were supposedly built by different cultures at different periods of time.

Regardless of the final conclusions reached by the reader, he must admit that these values are identical.

Another interesting correlation between the dimensions of the Tower Of Babel and the square of twelve is that its total volume is exactly 14,400,000 cubic Sumerian feet and that it was constructed with 57.6 million bricks ($144 \times 4 = 576$).

**Table E.1
Vectorial Expansion In Soybeans 1978 - 1992
And Corresponding Width Of Layers In The Tower Of Babel**

PTV™ In 1978 -1992 Spiral	Difference Between PTV™ In Column One And The PTV™ Preceding It	Corresponding Width Of Tower Of Babel
ZM = 139.9	N/A	N/A
NX = 345.0	NX - ZM = 205.1	205
PQ = 626.9	PQ - NX = 281.9	N/A
RS = 891.8	RS - PQ = 264.9	264
TV = 1180.6	TV - RS = 288.8	288

CHART E.1

DIMENSIONS OF ANCIENT MONUMENTS

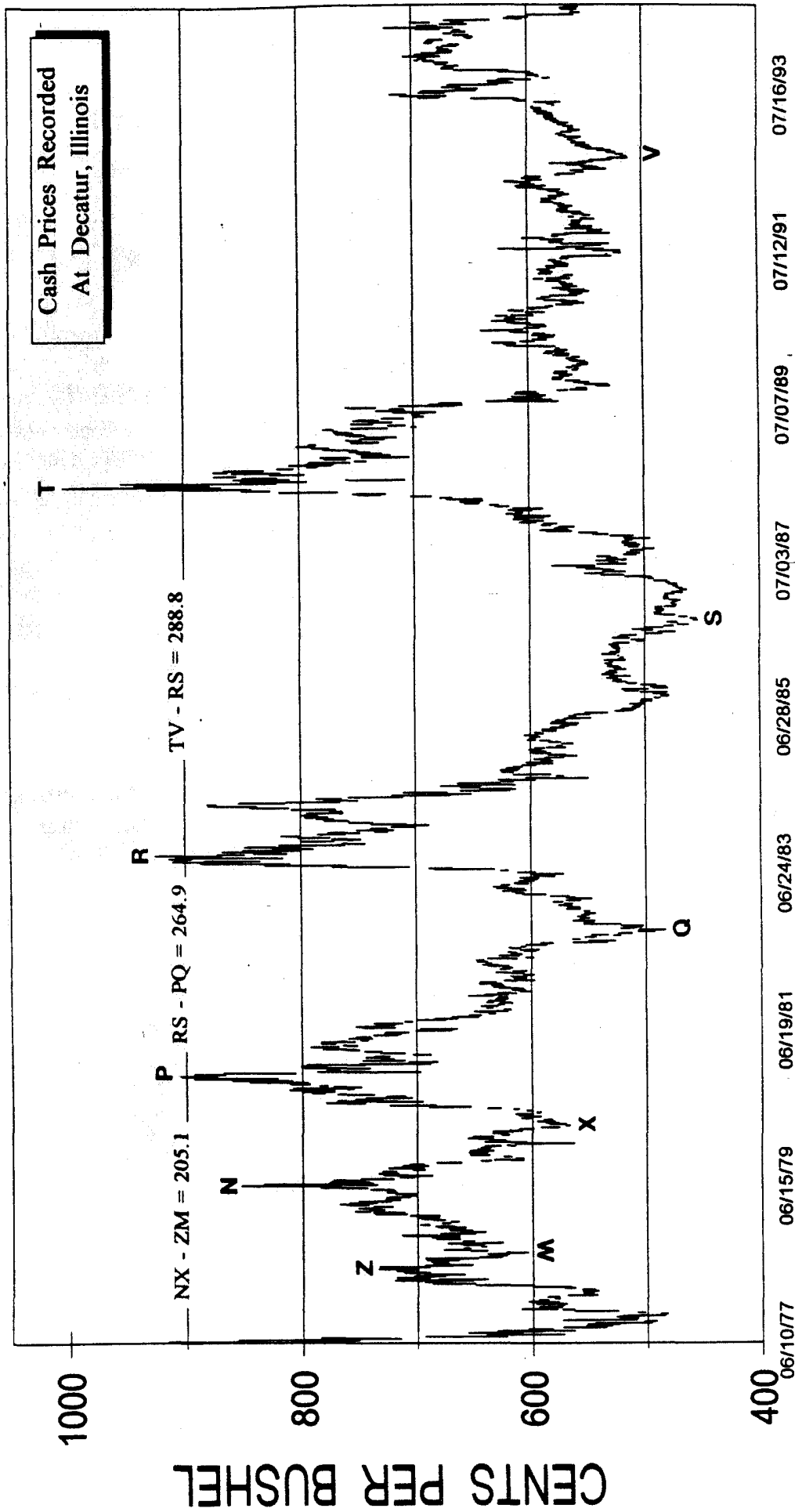

ZIGGURAT OF UR

Another monument found in the same part of the world as the Tower Of Babel is the Ziggurat Of Ur. This monument has exactly $1/6$ the volume of the Tower Of Babel and $1/36$ the volume of the pyramid at Cheops. The units shown in this figure are the same Sumerian feet used in the construction of the Tower Of Babel, shown in Figure E.1.

It is not surprising that the dimensions of this temple are also defined by the square of twelve. The Bible has many references to this number. Many scholars believe that the Hebrew authors of the Bible borrowed heavily from Sumerian legend when they were held captive in Babylonia and incorporated what they learned into the Bible. There is evidence to support their claims, including recently translated Sumerian tablets that contain a story very similar to that of Noah's Arc.

The obvious measurements in the Ziggurat Of Ur that are related to the square of twelve are 144, 72 and 36 because these are simple integral divisions of 144. The other measurements, such as 48, 96, 108, and 192 are also related to 144 when they are added together or subtracted in the appropriate combination.

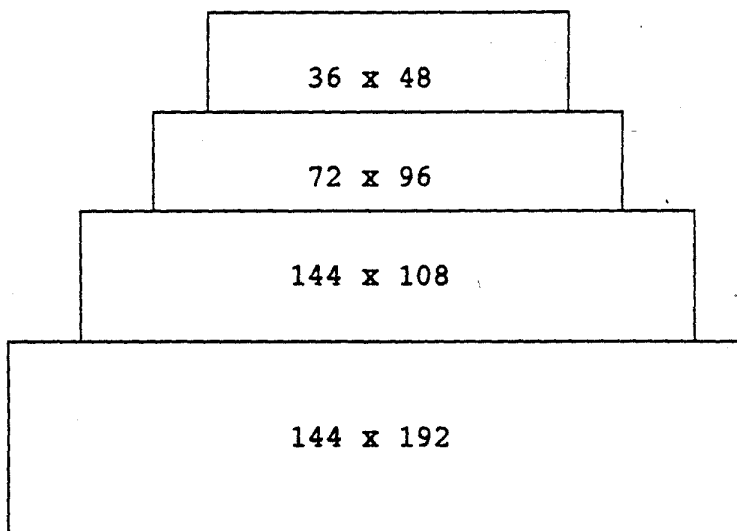

Figure E.2

Dimensions Of Ziggurat Of Ur In Sumerian Feet And The Square Of Twelve

TIAHUANACO RUINS

On the opposite side of the world from the Tower Of Babel and the Ziggurat Of Ur are ancient ruins known as Tiahuanaco in the country of Bolivia. These ruins also used the same dimensions found in the Tower Of Babel and the soybean market for their construction. Notice that the dimensions of the temple of Kalasasaya are the same as the PTV™ expansion shown in column two of Table E.1.

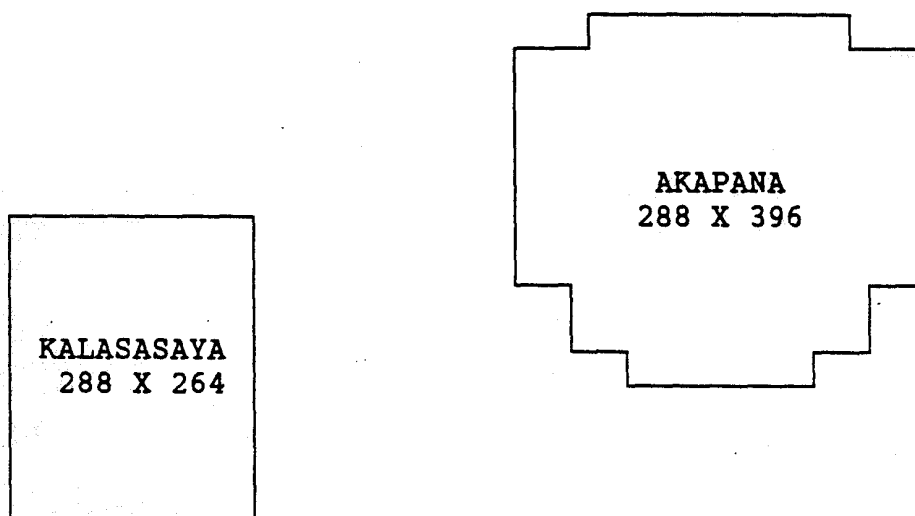

Figure E.3
Tiahuanaco Ruins In Bolivia And The Square Of Twelve

APPENDIX F

SQUARES IN 1966 - 1982 STOCK MARKET

The following explanation refers to Figure 5.2 in *Four-Dimensional Stock Market Structures And Cycles*. A reader asked,

"How can there only be two squares from point E to point G while there are only two equal size squares from F to G."

Response:

The problem is the way you are trying to view the three larger squares, EF, EG, and FG. These three squares are shown on a two dimensional plane, but are actually at different angles to each other in three-dimensions. That was explained on page 78 in *Four-Dimensional Stock Market Structures And Cycles* in the section "Three-Dimensional Perspective Of The 1966-1982 Square".

This structure takes the form of a "torus" or donut, as shown in Figure 13.8.

Figure F.1 puts all three of these points on a two-dimensional page, as was shown in Figure 5.2. To understand how this figure takes a three-dimensional form do the following:

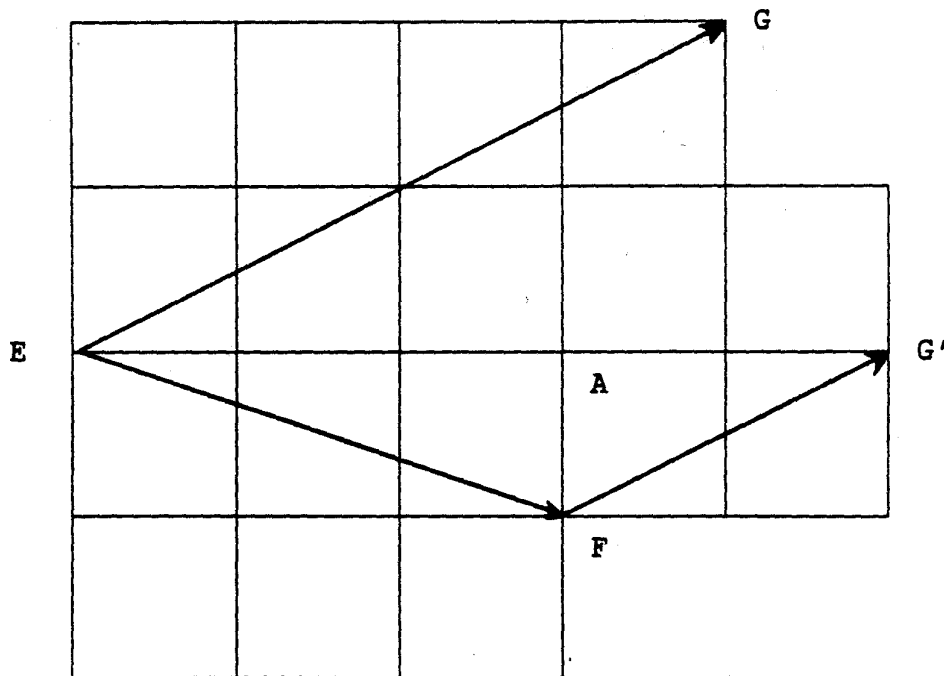

Figure F.1
Squares From Figure 5.2 In *Four-Dimensional Stock Market Structures And Cycles*

- (1) Trace Figure F.1 onto a separate sheet of paper.
- (2) Cut along the paper from point G' to A.
- (3) Fold the paper at a 90° angle along a line defined by EG'
- (4) Fold the paper at a 90° angle along a line defined by AG
- (5) Fold the paper to connect points G and G'

This will give you a three sided structure with point A at the corner.

Now look at plane holding FG with your line of vision perpendicular to it, as is done on a two-dimensional page. Notice that you only see two planes: the one with FG and the one with EF. You do not see EG.

Now look at the plane holding EF with your line of vision perpendicular to it. This is the condition that exists in Figure 5.2.b. You can see FG and it crosses two squares, as shown in Figure 5.2.b. However, since the plane holding EG is at a right angle to the plane holding EF (similarly, parallel to your plane of vision), you can not see EG when EF is perpendicular to your plane of vision.

Now look at the plane holding EG with your line of vision perpendicular to it. Notice that you can not see EF or FG because the planes holding them are parallel to your line of vision. While keeping the plane holding FG parallel to your line of vision, rotate the structure slightly so that you can see EF. This is the condition that exists in Figure 5.2.c. Notice that you still can not see FG and that EG and FG cover the number of squares shown in Figure 5.2.c.

FUTURE AREAS OF STUDY

Additional areas of study related to the topics presented in this series of books are:

Price-Time Triangulation

Growth Spirals

Fractal Analysis

DNA Coding

